



Ngai Shing Development Limited  
藝誠(余氏)發展有限公司

ALL FACETS OF  
GARMENT MACHINE  
製衣機器多元化



環境技術服務供應商登記號  
Registration Reference of Environmental  
Technology Service Provider : 11E0202

藝誠 (余氏) 發展有限公司 — 中國深圳

Ngai Shing Development Limited- Production Plant in Shenzhen, China



本公司不斷地研究開發新產品，務求滿足客戶最新要求。  
本書中所有產品的規格或零部件會隨時更新，到時恕不另行通知。  
本書內容僅供參考，一切以實物為準。

We are devoting ourselves to product development and technology improvement in order to meet customers' latest requirement continuously.  
Specifications and parts of all machines shown in this book are subject to be revised in the future.  
We are not going to re-inform unless otherwise required.  
This book is only for your reference, every detail should be based on the product you've received.



A	 <b>裁床部設備</b> Cutting Room Equipment	4
B	 <b>粘合機設備</b> Fusing Equipment	22
C	 <b>襯衫輔助設備</b> Shirt Assisting Equipment	30
D	 <b>自動縫紉設備及收料架</b> Shirt Auto-Sewing Equipment and Stackers	48
E	 <b>通用整熨設備</b> General Pressing & Ironing Equipment	58
F	 <b>男女襯衫專用整熨設備</b> Man & Lady Shirt Pressing Equipment	74
G	 <b>褲整熨及輔助設備</b> Trousers Ironing & Assisting Equipment	84
H	 <b>牛仔褲及衫表面處理設備</b> Jeans/Jacket Outlook Finishing Equipment	98
I	 <b>洗水設備</b> Washing Equipment	106
J	 <b>夾縫落樸防皺粘合壓平機</b> Seam Fusing Machine	124
K	 <b>藥水沉浸及焗爐設備</b> Chemical Dipping & Curing Oven Equipment	134
L	 <b>襯衫防皺整熨設備</b> Shirt Finishing Equipment	140
M	 <b>外衣整熨設備</b> Coat Ironing Room Equipment	156
N	 <b>風雨衣整熨設備</b> Rain Coat Ironing Equipment	158
P	 <b>其它設備</b> Other Machine	160

## Company Profile

**N**gaishing Development limited is a company specialized in garment machinery manufacturing, its original name is Ngaishing Engineering Manufactory, which was founded in 1954. Our distribution networks and service partners cover more than 40 countries over the world. The headquarters is in Hong Kong and manufacturing plant is located in Shenzhen China with a production plant of 40,000 square meters and employees of over 600.

We devote ourselves to the research and production of garment machines and concentrate our attention on the development of garment industry. Our products are simply classified into: Cutting Room Equipment, Fusing Equipment, Shirt Assisting Equipment, Shirt Auto-sewing Equipment & Stackers, General Pressing & Ironing Equipment, Man & Lady Shirt Pressing Equipment, Trousers Ironing and Assisting Equipment, Jeans/Jacket Outlook Finishing Equipment, Industrial Laundry Equipment, Seam Fusing Equipment, Chemical Dipping & Curing Oven Equipment, Shirt Anti-wrinkle Pressing Equipment, Coat Ironing Room Equipment, Rain Coat Ironing Equipment,

etc.. All the above count up to over 500 items and cover nearly all facets of garment manufacturing.

We have also got several patented designs on heating element, heat transfer system, pressing system and patent for energy saving drying tumbler. We have been trying our best to upgrade our products and make its price be competitive by continuous adoption of new machines and technologies and expansion of production scale. Especially Ngai Shing is an environmental technology service provider authorized by the government of Hong Kong Special Administrative Region under the program of Cleaner Production Partnership(ET registration reference: 11E0202) and we have got the certificate of "Hong Kong-Guangdong Cleaner Production Partner", so we could provide large scale technology support and service to our customers.

We have been trying our best to serve the garment manufacturers and persisting in our goal as "All facets of garment machines". For years we had been enjoying good reputation for our services to our customers. We sincerely hope that we could march on hand in hand with our customers to the future of garment manufacturing.

## 藝誠

誠(余氏)發展有限公司是專業生產服裝機械的廠家，其前身為藝誠機器製造廠，成立於1954年，經銷網絡分佈40多個國家，產品銷往世界各地。公司總部設於香港，生產廠房位於中國深圳經濟特別行政區，現有廠房超過40,000m<sup>2</sup>，員工600餘人。

藝誠公司一直關注著服裝生產業的發展動向，致力於服裝製造機械的研發與生產。公司產品主要包括：裁床部設備，粘合機設備，襯衫輔助設備，自動縫紉設備及收料架，通用整熨設備，男女襯衫專用整熨設備，褲整熨及輔助設備，牛仔褲及衫表面處理設備，洗水設備，夾縫落樸防皺粘合設備，藥水沉浸及焗爐設備，襯衫防皺整熨設備，外衣整熨設備，風雨衣整熨設備等，共500多個品種，覆

蓋了成衣加工的方方面面。

藝誠公司擁有多項“加溫、傳熱、加壓”技術的註冊專利及“節能乾衣機”註冊專利，並不斷更新設備，引進技術，擴大生產，務使產品的性能更佳，產品的價格更具競爭力。藝誠還是香港特別行政區政府批准的清潔生產夥伴計劃環境技術服務供應商(編號:11E0202)，并榮獲“粵港清潔生產伙伴”資格認證，可給客戶提供全方位的技術支援和服務。

藝誠公司竭誠為廣大服裝生產廠家服務，為實現“制衣設備多元化”的目標而不懈地努力。多年以來藝誠的服務質素一直為用戶所稱道，我們熱忱希望能和廣大成衣製造同仁攜手並進，邁向一個又一個的服裝生產的新高點。

## 公司簡介

### Company Vision

- Reliability** Standardize product quality, ensure product provide consistent performance and productivity
- Experience** Provide professional consultancy
- Service** Working with our customers as "Business Partner" ensure we continuously respond to their changing needs
- Technology** Develop innovative automation products to capture market opportunities

### 公司目標

- 耐用可靠** 統一產品規格和品質，使產品能提供穩定功能及生產量。
- 經驗豐富** 專業顧問精神，給顧客提供最合理的生產建議。
- 優質服務** 誠意與顧客成為“合作伙伴”，不斷回應顧客的需要。
- 擴展科技** 鑽研及創新自動化產品，擴展市場空間。



# 裁床部設備

## Cutting Room Equipment

A

### NS-521

輕型組合式裁床  
Light Duty Flexible Cutting Table

### NS-522

輕型防火板面組合式裁床  
Light Duty Laminated Flexible Cutting Table



### NS-523

重型組合式裁床  
Heavy Duty Flexible Cutting Table

### NS-524

重型防火板面組合式裁床  
Heavy Duty Laminated Flexible Cutting Table



NS-521,NS-522裁床結構圖  
Structure of NS-521 & NS-522

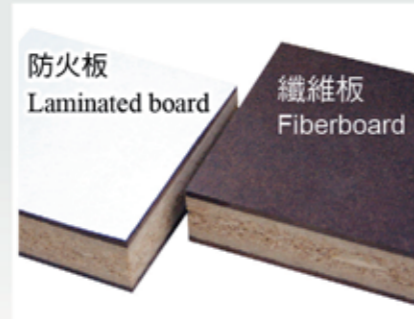

台面材質對比  
Material of table top



NS-523,NS-524裁床結構圖  
Structure of NS-523 & NS-524

型號 Model	結構型式 Structure	台面材質 Table Top Material	台面寬度Table Width(inch)		每節長度 Length of each section(inch)	台腳可調高度 Adjustable leg height(inch)
			二腳 2 Legs	三腳 3 Legs		
NS-521	輕型 Light-duty	纖維板 Fiberboard	54、66	72、84	48	31~37
NS-522		防火板 Laminated Board				
NS-523	重型 Heavy-duty	纖維板 Fiberboard				30~34
NS-524		防火板 Laminated Board				

A

### NS-521-A

輕型氣墊式組合式裁床  
Floatation Light Duty Flexible Cutting Table

### NS-522-A

輕型氣墊式防火板面組合式裁床  
Floatation Light Duty Laminated Flexible Cutting Table

### NS-523-A

重型氣墊式組合式裁床  
Floatation Heavy Duty Flexible Cutting Table

### NS-524-A

重型氣墊式防火板面組合式裁床  
Floatation Heavy Duty Laminated Flexible Cutting Table



### NS-521-B

輕型抽風式組合式裁床  
Vacuum Light Duty Flexible Cutting Table

### NS-522-B

輕型抽風式防火板面組合式裁床  
Vacuum Light Duty Laminated Flexible Cutting Table

### NS-523-B

重型抽風式組合式裁床  
Vacuum Heavy Duty Flexible Cutting Table

### NS-524-B

重型抽風式防火板面組合式裁床  
Vacuum Heavy Duty Laminated Flexible Cutting Table

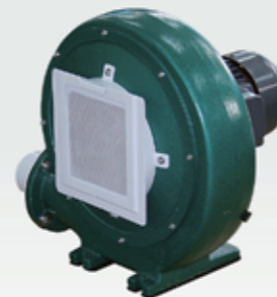

NS-3402-3  
鼓風機  
Blower

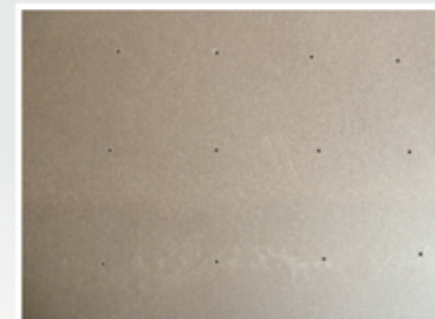

台面風孔  
Table air hole



NS-3401-1.5  
抽風泵  
Vacuum pump

型號 Model	結構型式 Structure	台面材質 Table Top Material	樣式 Style	台面寬度Table Width(inch)		每節長度 Length of each section(inch)	台腳可調高度 Adjustable leg height(inch)
				二腳 2 Legs	三腳 3 Legs		
NS-521-A	輕型 Light-duty	纖維板 Fiberboard	氣墊式 Floatation	54、66	72、84	48	31~37
NS-521-B			抽風式 Vacuum				
NS-522-A		防火板 Laminated Board	氣墊式 Floatation				
NS-522-B			抽風式 Vacuum				
NS-523-A	重型 Heavy-duty	纖維板 Fiberboard	氣墊式 Floatation	54、66	72、84	48	30~34
NS-523-B			抽風式 Vacuum				
NS-524-A		防火板 Laminated Board	氣墊式 Floatation				
NS-524-B			抽風式 Vacuum				

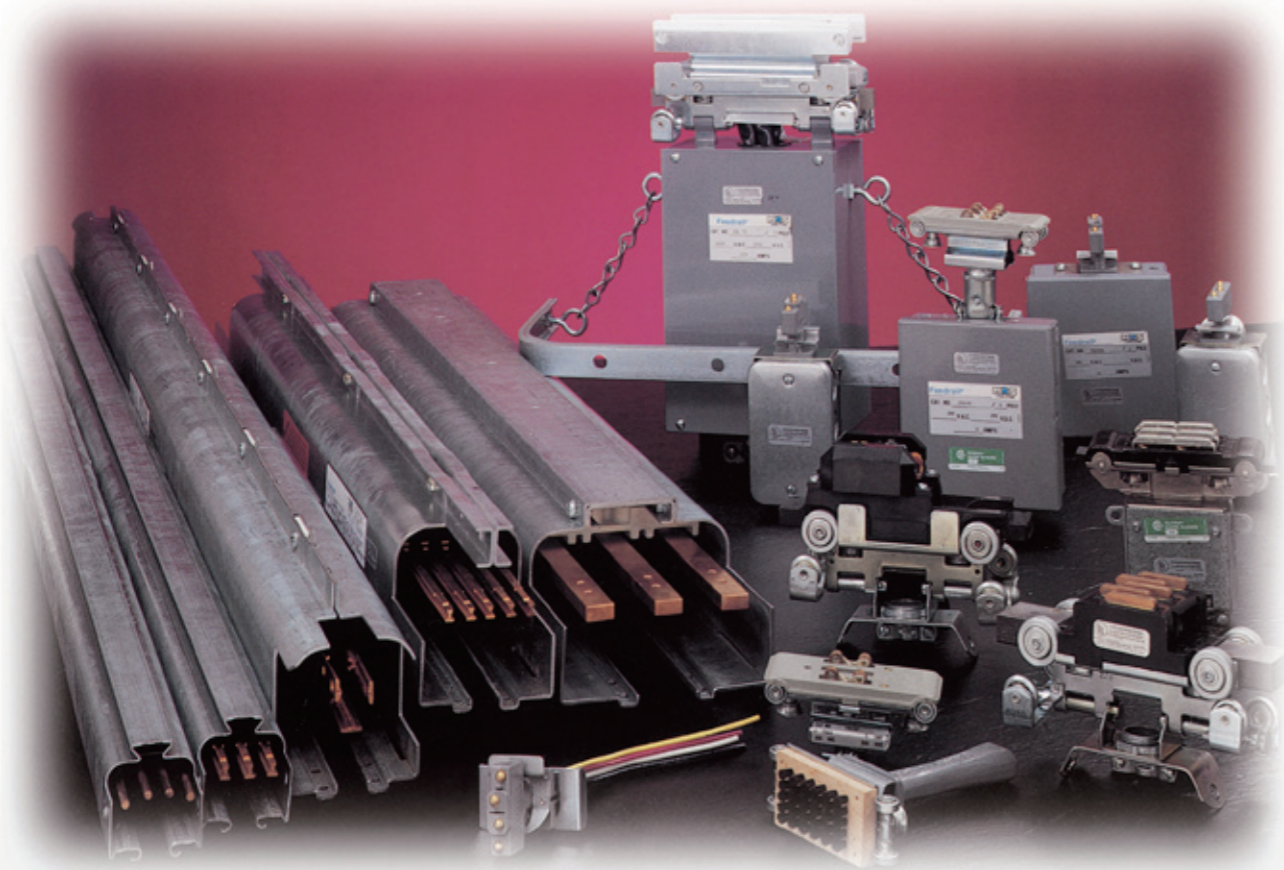

### 電槽及電車仔 Bus bar and trolley

- 活動式組合，易於安裝及拆散，方便將來加長或縮短。
- 適用於裁床部、縫紉部、整燙部
- Flexible construction for easy assembling and disassembling, also enable for future prolonging and shortening.
- Suitable for cutting department, sewing department and ironing department.

### NS-601

針床連燈架  
Pinning Table with Light Stand



### NS-630

裁件定位燈座連三支定位燈  
Marking Table with 3 Light Markers

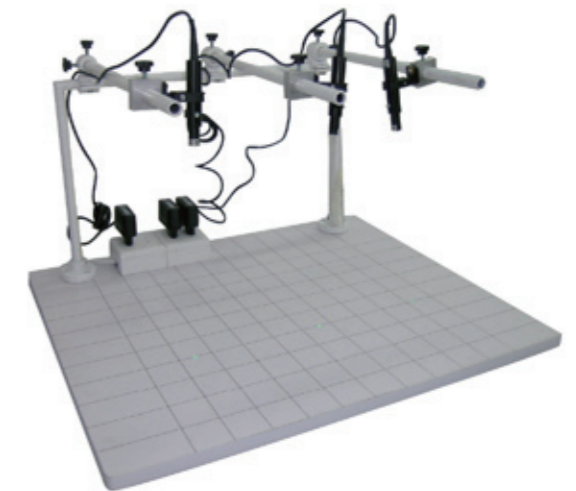

選購件：  
NS-6203C-2M 十字鐳射燈  
Option：  
NS-6203C-2M Cross Laser Marker

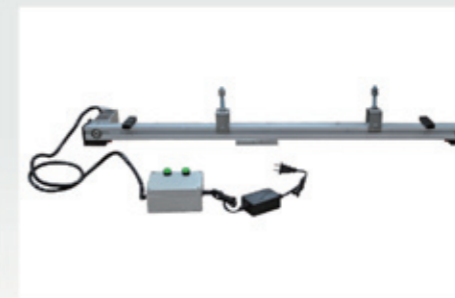

選購件：O-A-03-7  
鐳射燈自動可調支架2  
Option: Automatic Adjustable Support 2  
適用於NS-601 系列  
Suitable for NS-601 series

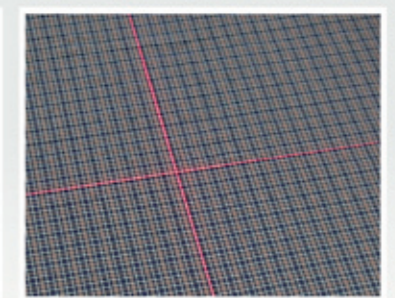

十字光線方便對格子操作  
Purchasing cross laser marker for  
facilitating check matching

型號 Model	電源 Power Supply	總功率 Total Power(kW)	檯面尺寸 Table Size(cm)
NS-601	1PH/220V/50Hz	0.2	120x180
NS-601-1			120x240
NS-630			60x70



A

### NS-6203S-7M

直線鐳射燈 — 紅色  
Straight Laser Marker — Red

### NS-6213S-7M

直線鐳射燈 — 綠色  
Straight Laser Marker — Green

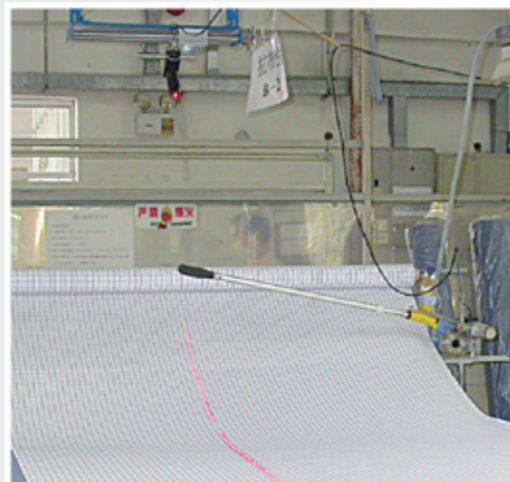
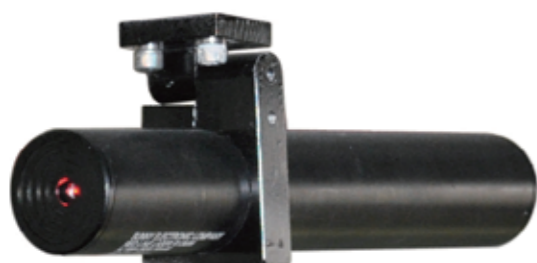

NS-6203S-7M 產生直線光投射記號，定位簡單準確，最適用於裁床定位。  
Produce a straight laser line mark for easy and accurate positioning, best for fabric laying

### NS-6202S-2M

直線鐳射燈 — 紅色  
Straight Laser Marker — Red



### NS-6205S-60MM/NS-6205S-340MM

直線鐳射燈 — 紅色  
Straight Laser Marker — Red



型號 Model	鐳射光線長度 Laser beam length	電源 Power Supply	鐳射燈功率 (mW) Laser Power	光線顏色 Beam Color	直徑 (mm) Dia	光線形式 Beam Shape	鐳射安裝高度 (m) Mounting height of Laser marker	可選購鐳射燈可調支架 Optional: adjustable support of laser marker
NS-6202S-2M 直線鐳射燈 Straight Laser Marker	2m	1PH/220V/50Hz	8	紅 Red	Ø20x95	直線 Straight	1.5	O-A-03-7 鐳射燈自動可調支架2 Automatic Adjustable Support 2 of Laser Marker
NS-6212S-2M 直線鐳射燈 Straight Laser Marker				綠 Green				
NS-6203S-7M 直線鐳射燈 Straight Laser Marker	7m	AC 100~240V 50~60Hz	13	紅 Red	Ø30x125			O-A-03-6 鐳射燈自動可調支架1 Automatic Adjustable Support 1 of Laser Marker
NS-6213S-7M 直線鐳射燈 Straight Laser Marker				綠 Green				
NS-6205S-60MM 直線鐳射燈 Straight Laser Marker	60mm	DC 3.2V	4	紅 Red	Ø12x50		0.04	—
NS-6205S-340MM 直線鐳射燈 Straight Laser Marker	340mm			8				

A

### NS-6203C-2M

十字鐳射燈 — 紅色  
Cross Laser Marker — Red

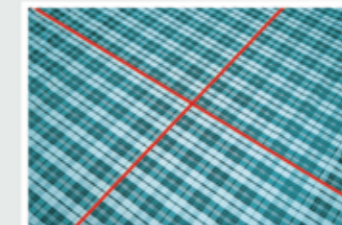

十字鐳射燈可使格子布對位容易  
Cross Laser Marker makes check fabric matching easily



十字鐳射燈可助對位  
Cross Laser Marker can be used for position marking

### 鐳射燈可調支架(選購件)

### Adjustable Support of Laser Marker(optional parts)

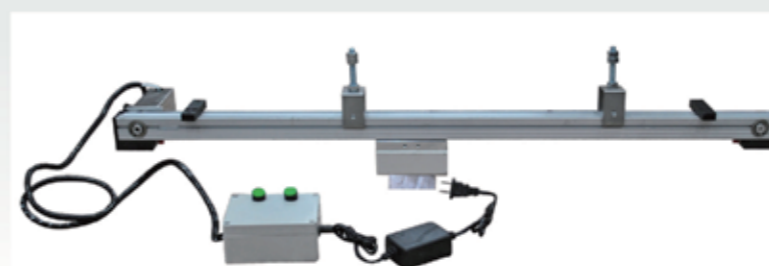

O-A-03-6  
鐳射燈自動可調支架 1  
Automatic Adjustable Support 1  
(應配合AC-A-6-4一起使用  
should be used with AC-A-6-4 together)

鐳射燈安裝在支架1上  
Laser Marker Mounted on the Support 1

型號 Model	鐳射光線長度 Laser beam length	電源 Power Supply	鐳射燈功率 (mW) Laser Power	光線顏色 Beam Color	直徑(mm) Dia.	光線形式 Beam Shape	鐳射安裝高度 (m) Mounting height of laser marker	可選購鐳射燈可調支架 Optional: adjustable support of laser marker
NS-6203C-2M 十字鐳射燈 Cross Laser Marker	2m	1PH/220V/50Hz	8	紅 Red	Ø30x100	十字線 Cross	1.5	O-A-03-7 鐳射燈自動可調支架2 Automatic Adjustable Support 2 of Laser Marker
NS-6213C-2M 十字鐳射燈 Cross Laser Marker				綠 Green				
NS-6204C-3x3MM 十字鐳射燈 Cross Laser Marker	3mm	DC 3.2V	6	紅 Red	Ø20x100		0.2~0.3	—
NS-6214C-3MM 十字鐳射燈 Cross Laser Marker				綠 Green				



A

### 鐳射燈安裝示意圖

### Laser Marker Installation Diagram

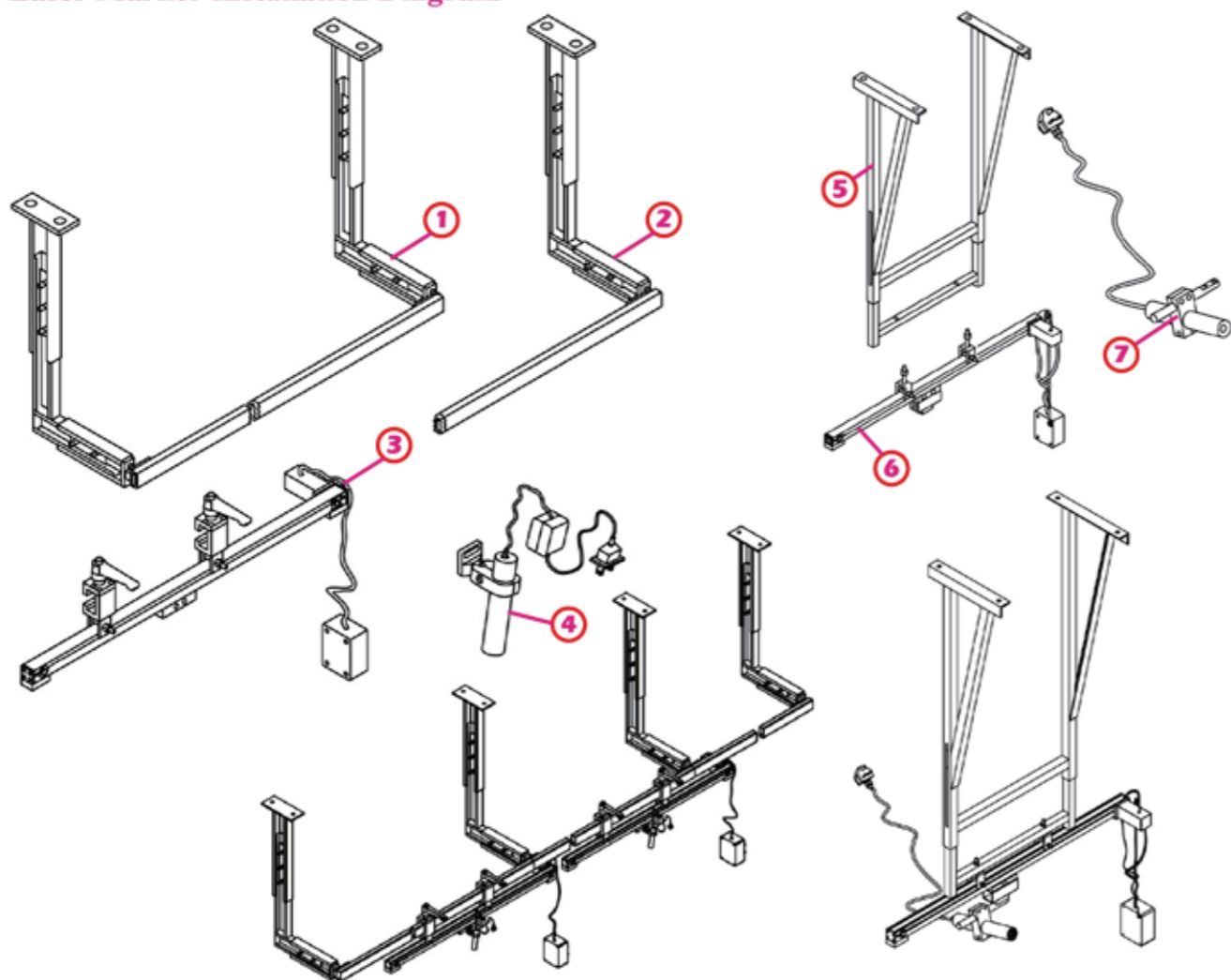

指引號 Ref. No.	公司編號 Company Code	中文名稱 Chinese Description	英文名稱 English Description
1	O-A-03-8	路軌吊桿支架短頭尾節(10')	Short Front and End Segments of Rail Hanging Rod Support(10')
2	O-A-03-9	路軌吊桿支架中間節(10')	Middle Segment of Rail Hanging Rod Support(10')
3	O-A-03-7	鐳射燈自動可調支架2	Automatic adjustable support 2 of laser marker
4		鐳射燈組合	Laser marker assembly
4-1	NS-6202S-2M	直線鐳射燈-紅	Straight Laser Marker-Red
4-2	NS-6212S-2M	直線鐳射燈-綠	Straight Laser Marker-Green
4-3	NS-6203C-2M	十字鐳射燈-紅	Cross Laser Marker-Red
4-4	NS-6213C-2M	十字鐳射燈-綠	Cross Laser Marker-Green
5	AC-A-7-6-1	可調直線鐳射燈支架	Adjustable Support for Straight Laser Marker
6	O-A-03-6	鐳射燈自動可調支架1	Automatic adjustable support 1 of laser marker
7		鐳射燈組合	Laser marker assembly
7-1	NS-6203S-7M	直線鐳射燈-紅	Straight Laser Marker-Red
7-2	NS-6213S-7M	直線鐳射燈-綠	Straight Laser Marker-Green

A

### NS-52

拉布機 (不連角鐵路軌)  
Expandable Cloth  
Spreader(without L track)



### NS-57

切布機 (縱直紋)  
Fabric Cutting Machine  
(straight & bias cutting)



### NS-69

切布機 (短柄-推) 全台  
End Cutter(Short Handle-Push)  
Complete Set

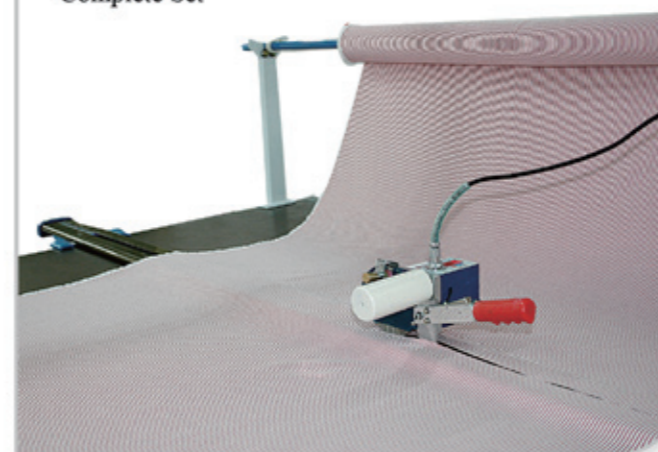

### NS-70

切布機 (長柄-推) 全台  
End Cutter(Long Handle-Push)  
Complete Set

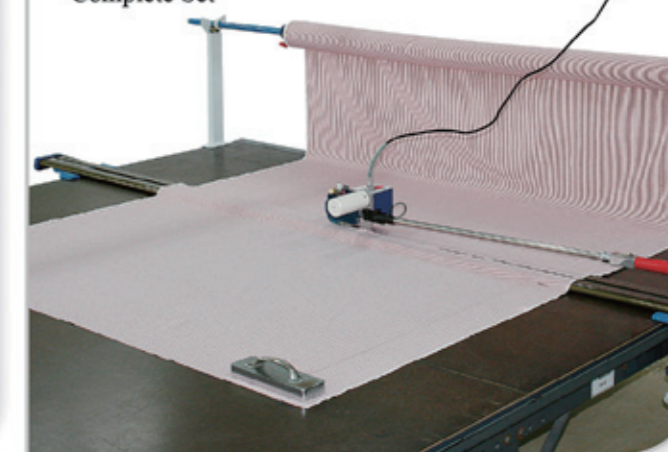

型號 Model	電源 Power Supply	總功率 Total Power( HP)	適合裁床闊度 Cutting Table Width(inch)	拉布闊度 Spread Cloth Width(inch)	機身尺寸 Machine Size(cm)
NS-52	---	---	60~84	56~80	180x76x68
NS-57	1PH/220V/50Hz	0.2	72	56~70	304x45x28
NS-69		0.13	84	---	304x25x16*
NS-70					



A

### NS-58

自動對邊捲布驗布機(有電眼裝置)  
Cloth Winding Inspection Machine with Edge Control Device(with automatic electric eye)



### NS-59

捲布驗布機(無電眼)  
Cloth Winding Inspection Machine(without automatic electric eye)



A



鬆布系統(選購件)  
Fabric loosening system(Option)

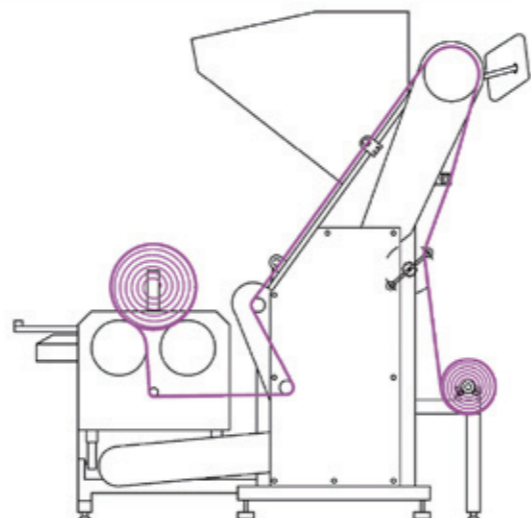

NS-58/NS-59電子計數布碼表，記錄布匹長度  
Equipped with electronic meter for recording cloth winding length

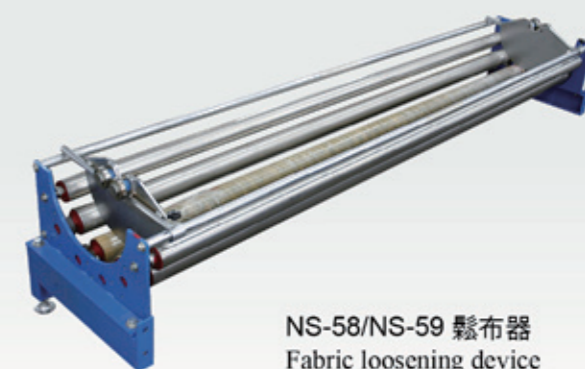

NS-58/NS-59 鬆布器  
Fabric loosening device

型號 Model	電源 Power Supply	總功率 Total Power(kW)	工作闊度 Working Width(inch)	捲布直徑(inch) Cloth Winding Dia.	淨重 Net Weight (kg)	機身尺寸 Machine Size (cm)	
NS-58H-72	3PH/380V/50Hz	2.3	72	15	1040	259x180x187*	
NS-58H-84			84		1180	288x180x187*	
NS-58H-96			96		1310	318x180x187*	
NS-58L-72			72	778	259x175x187	12	288x175x187*
NS-58L-84			84	797	288x175x187*		
NS-58L-96			96	816	318x175x187*		

型號 Model	電源 Power Supply	總功率 Total Power(kW)	工作闊度 Working Width(inch)	捲布直徑(inch) Cloth Winding Dia.	淨重 Net Weight(kg)	機身尺寸 Machine Size(cm)
NS-59H-72	1PH/220V/50Hz	1.66	72	15	650	237x155x200
NS-59H-84			84		710	267x155x200
NS-59H-96			96		750	297x155x200
NS-59L-72		72	380	237x116x200	12	267x116x200
NS-59L-84		84	510	267x116x200		
NS-59L-96		96	525	297x116x200		
NS-58鬆布系統(選購件) Fabric loosening system(option)		0.37	72	-	150	242x75x88
			84		180	265x75x88
			96		220	295x75x88





A

### NS-810

氣墊運剪刀床  
Bandknife Cutting Machine with Air Float Table



### NS-1110

駁布開骨機(不連衣車頭)  
Cloth Joining and Seam Opening  
Machine(without sewing machine head)

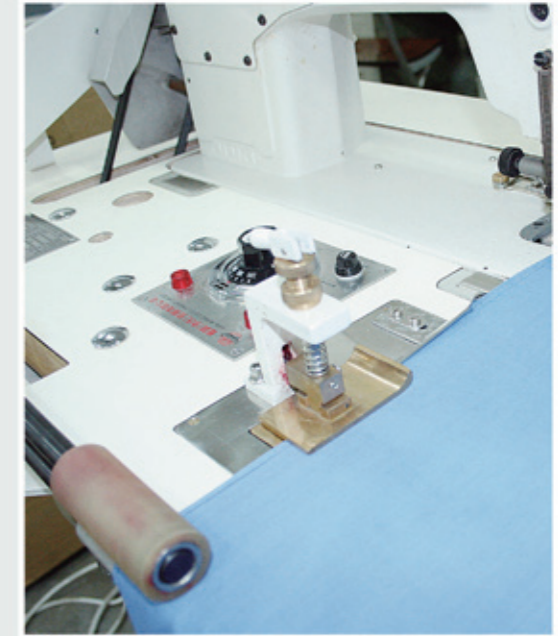

NS-1110 開骨及折紙口  
Open seam and fold margin

### NS-1150

針織切細條機  
Knit Fabric Cutting Machine



NS-1150工作中  
In working



選購件：布夾A618-1  
Option: Cloth clamp A618-1



選購件：三指及五指鋼絲手套  
Options: 3 fingers and 5 fingers metal gloves

型號 Model	電源 Power Supply	總功率 Total Power(kW)	檯面尺寸 Table Size(cm)	無段變速速度 Stepless Speed (m/s)	刀帶尺寸 Knife Size(mm)	淨重 Net Weight(kg)	毛重 Gross Weight(kg)	機身尺寸 Machine Size (cm)
NS-810-700	1PH/220V/50Hz	0.9	120x160	11.5~20	0.45x10x3500	250	390	196x121x160
NS-810-900			122x200		0.45x10x3860	308	445	236x121x160

型號 Model	電源 Power Supply	總功率 Total Power(kW)	淨重 Net Weight(kg)	毛重 Gross Weight(kg)	機身尺寸 Machine Size(cm)
NS-1110	1PH/220V/50Hz	0.2	60*	90*	215x115x135*
NS-1150			43	64	158x77x126

A



# 裁床部設備

## Cutting Room Equipment

A

### NS-1121

自動對邊縱直紋捲布機  
Bias & Vertical Cloth Winding  
Machine with Edge Control



### NS-1122

縱直紋捲布機  
Bias & Vertical Cloth  
Winding Machine

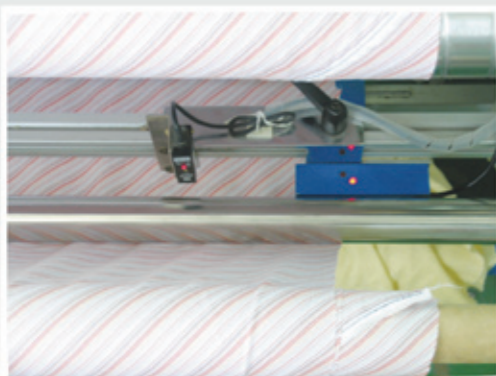

NS-1121對邊感測器/缺料感測器  
Edge sensor/no cloth detector



NS-1121縱直紋切布刀  
Cutter

型號 Model	電源 Power Supply	總功率 Total Power(kW)	最大捲料速度 Max. Winding Speed(m/min)	捲料最大直徑 Max. Winding Dia.(inch)	最大工作寬度 Max. Working Width (inch)	淨重 Net Weight (kg)	機身尺寸 Machine Size (cm)
NS-1121-72	1PH/220V/50Hz	1.3	130	9	72	500	234x97x153
NS-1121-90					90	520	265x97x153
NS-1122-72					72	420	234x97x153
NS-1122-90					90	440	265x97x153

A

### NS-1130S

切細條機連磨刀機  
Ribbon Cutting Machine with  
Sharpening Device



### NS-1132

數控半自動切細條機連磨刀機  
Digital Control Semi-Automatic  
Ribbon Cutting Machine with  
Sharpening Device



電源控制箱  
Electric Control Box



NS-1132 工作中  
In working



NS-1130S&NS-1132 效果圖  
Finished result

型號 Model	電源 Power Supply	總功率 Total Power(kW)	工作闊度 Working Width(inch)	淨重 Net Weight(kg)	機身尺寸 Machine Size(cm)
NS-1130S-72	3PH/380V/50Hz	3	72	650*	293x102x132
NS-1130S-90			90	710*	354x102x132
NS-1132-72			72	670	284x116x140
NS-1132-90			90	720	335x116x140



A

### NS-850

油壓平面裁斷機  
Hydraulic Plane Cutting Press



### NS-870-30

龍門式油壓裁斷機  
Traveling Head Hydraulic Cutting Press



### NS-532

針織驗布機連鬆布撥  
Knitting Fabric Inspection Machine  
with Loosing Spreader



### NS-63-72

牛仔布驗布、鬆布機  
Denim Inspecting & Loosening Machine



### NS-860

搖臂式油壓裁斷機  
Hydraulic Swing Arm Cutting Machine



可選購各種裁斷刀具  
Optional cutting tools

### NS-56

鬆布機  
Fabric Loosening Machine



NS-532/NS-56選購附件：A2016-1 放布板層架  
Optional accessory: A2016-1 fabric support

型號 Model	電源 Power Supply	馬達功率 Power of Motor(kW)	裁斷壓力 Fabric Cutting Force (tons)	裁斷面積 Cutting Area (cm)	最大沖程 Max.Stroke (mm)	機身尺寸 Machine Size (cm)	
NS-850-30S	3PH/380V/50Hz	3	30	61x122	165	206x127x170	
NS-850-30L				61x160		233x132x126	
NS-850-50S				61x122		185x132x126	
NS-850-50L		61x160	195x132x126				
NS-860-25-1		1.1	25	61x61		100	100x100x137
NS-870-30		4	30			165	233x113x188

A

型號 Model	工作寬度 Working Width(inch)	電源 Power Supply	總功率 Total Power(kW)	機身尺寸 Machine Size(cm)
NS-56	90	1PH/220V/50Hz	1.1	292x82x125
NS-532			1.5	296x170x202
NS-63-72			1.5	283x154x215



A

### NS-158

自動對邊夾棉捲驗機  
Poly Felt Inspection & Winding  
Machine with Edge Control

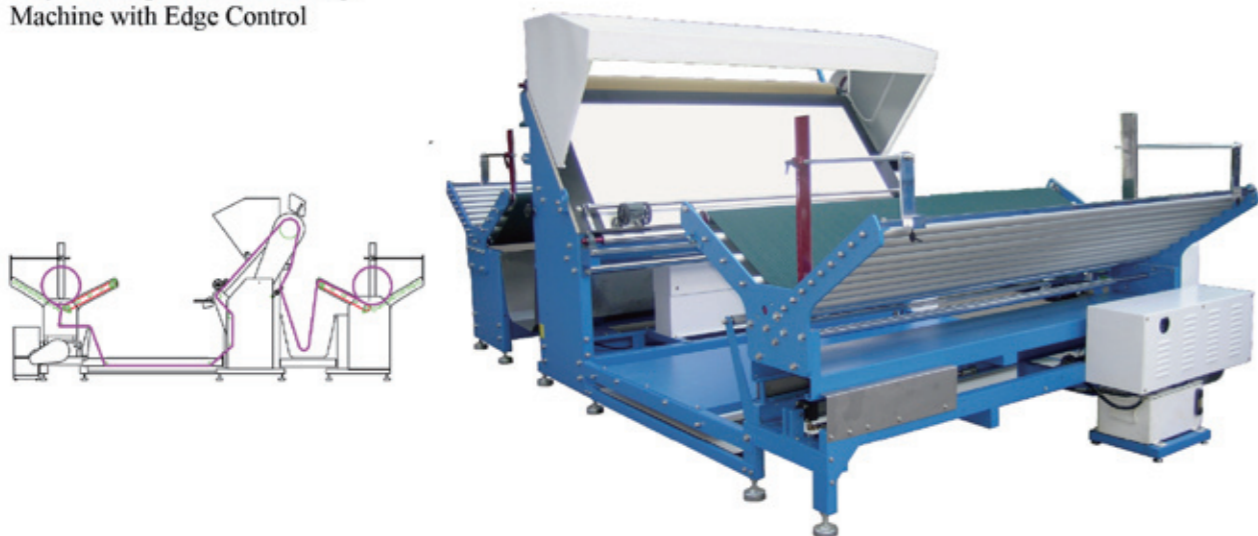

### NS-501

自動梳織拉布機  
Automatic Woven Fabric Spreader



A

### NS-398

蒸汽鬆布定型機  
Steam fabrics Loosing Fixing Machine

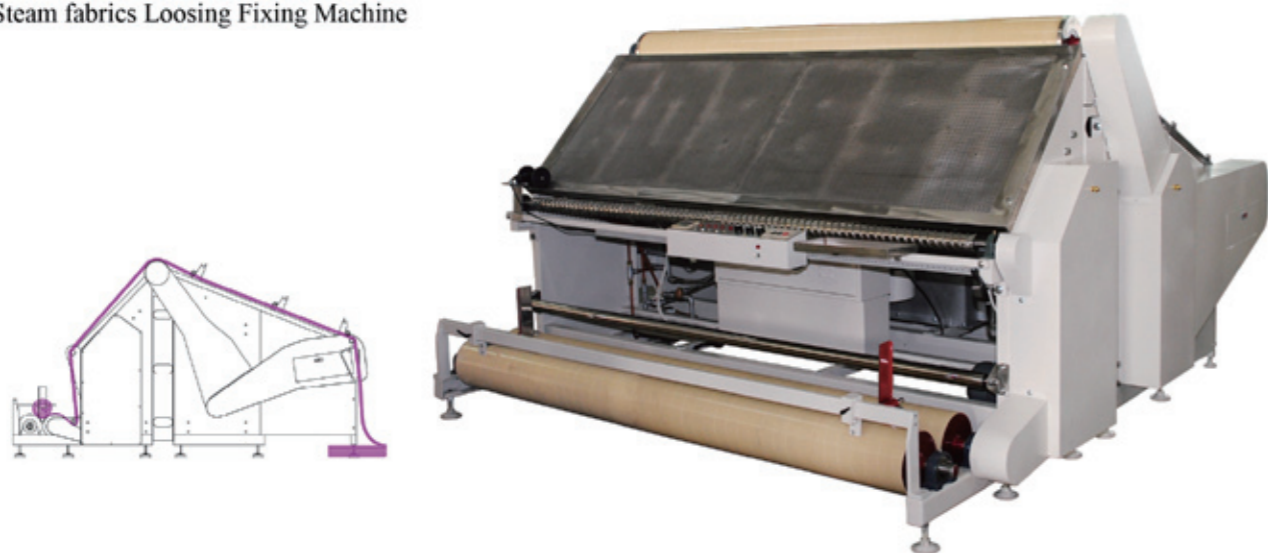

### NS-502

手動拉布機連切布機  
Manual Cloth Spreader

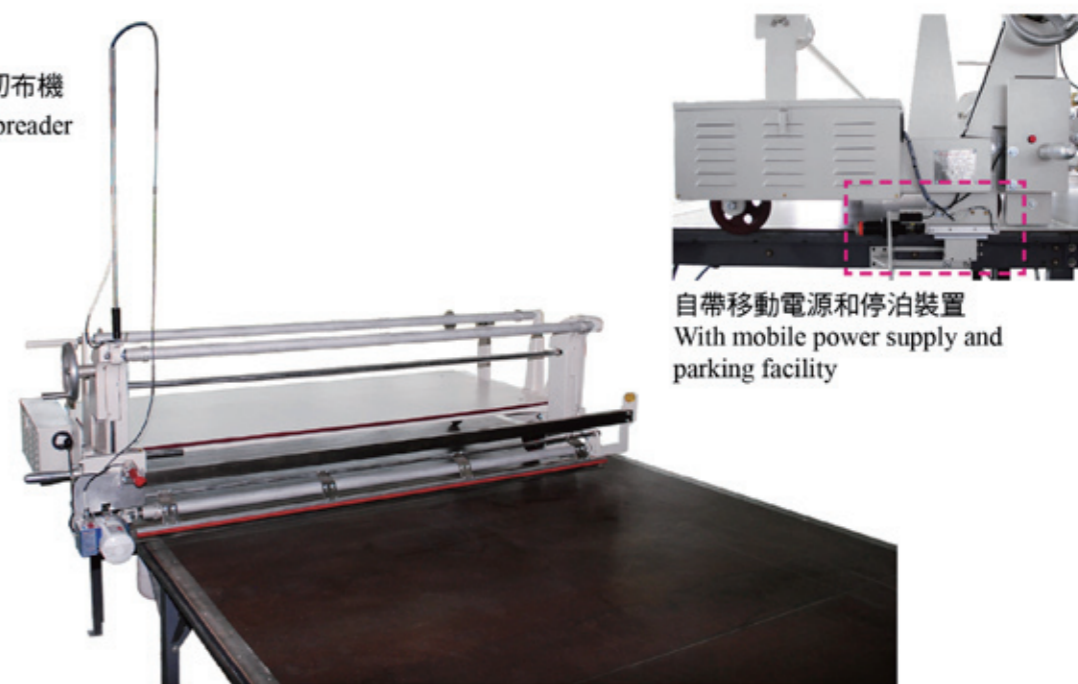

自帶移動電源和停泊裝置  
With mobile power supply and parking facility

型號 Model	電源 Power Supply	總功率 (kW) Total Power	加工寬度 (inch) Working width	可捲直徑 (mm) Possible winding dia.	調速範圍 (RPM) Cloth loosening speed range	前預縮區 front shrinking area(mm) · 後預縮區 back shrinking area(mm)	蒸汽工作壓力 (kg/cm <sup>2</sup> ) Working steam pressure	耗蒸汽量 (kg/hr) Steam consumption	機身尺寸(cm) Machine Size
NS-158	3PH/380V/50Hz	3.8	—	Ø32~Ø1200	16~160	—	—	—	440x235x190
NS-398		5	84	—	—	2220x715, 2220x635	3~5	150~250	255x285x159

型號 Model	適合裁床闊度(inch) Cutting Table width	拉布闊度(inch) Spread Cloth width	總功率(kW) Total Power	機身尺寸(cm) Machine Size
NS-501-54	54	48	1.6*	—
NS-501-66	66	60		212x155x77
NS-501-72	72	66		212x186x77
NS-501-84	84	78		212x216x77
NS-502-54	54	48	0.13	181x117x71
NS-502-66	66	60		216x117x71
NS-502-72	72	66		228x117x71
NS-502-84	84	78		240x117x71



B

**NS-93-1**  
點模機  
Spot Welding Machine



將模布及領布預先定位,  
避免在粘合過程中移位  
Pre-fix interlining with fabric for  
avoiding shift during fusing



**NS-9301**  
自動點模機  
Automatic Spot Welding Machine



自動收料  
Automatic material stacking

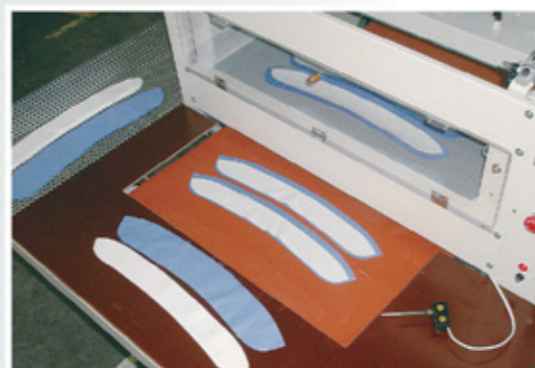

**NS-5600-450**  
粘合機(自動平衡系統)  
Fusing Machine(Automatic Balancing System)



控制面板, 操作簡單  
Control panel, easy to operate



清潔系統  
Cleaning system



**NS-2610**  
粘合機  
Fusing Machine

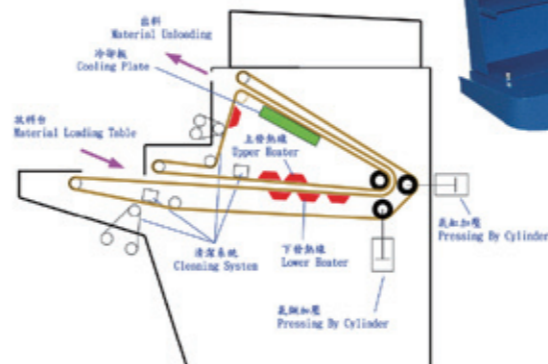

前面入料、收料, 方便操作  
Front material feeding and collecting for convenient operation



型號 Model	電源 Power Supply	總功率 (kW) Total Power	壓縮空氣壓力 Compressed Air Pressure (kgf/cm <sup>2</sup> )	平均粘合壓力 Average Fusing Pressure(kgf/cm <sup>2</sup> )	耗壓縮空氣量 Compressed Air Consumption (L/min)	最大工作闊度 Max. Working Width(mm)	裝箱尺寸 Packing Size(cm)
NS-93-1	1PH/220V/50Hz	0.08	---	---	---	---	71x16x14
NS-9301	3PH/380V/50Hz	6.4	5	0.3	150	660	131x140x157

B

型號 Model	工作闊度 Working Width (mm)	電源 Power Supply	總功率 (kW) Total Power	最高設計溫度 Max. Design Temp.(°C)	加壓方式 Pressure Increasing Mode	壓縮空氣壓力 Compressed Air Pressure (kgf/cm <sup>2</sup> )	平均粘合壓力 Average Fusing Pressure (kgf/cm <sup>2</sup> )	機身尺寸 Machine Size(cm)
NS-5600-450	450	1PH/220V/50Hz	4.6	200	彈簧加壓By Spring	---	0.5	167x88x50
NS-2610	600	3PH/380V/50Hz	9		氣缸加壓By Air Cylinder	5	1.0	164x195x154



B

### NS-5610

粘 合 機  
Fusing Machine

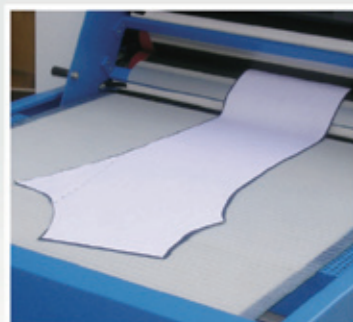

風冷卻收料台  
Pneumatic cooling & collecting table

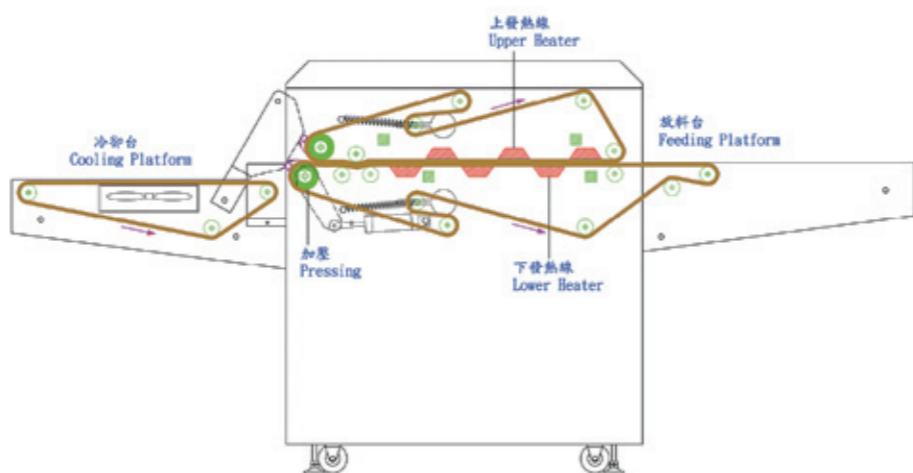

型號 Model	粘帶寬 Belt Width (mm)	電源 Power Supply	發熱線功率 Heater Power (kW)	加壓方式 Pressure Increasing Mode	壓縮空氣壓力 Compressed Air Pressure (kgf/cm <sup>2</sup> )	平均粘合壓力 Average Fusing Pressure (kgf/cm <sup>2</sup> )	最高溫度(°C) Max Temp.	機身尺寸(cm) Machine Size
NS-5610-600	600	3PH/380V/50Hz	9.6	氣缸加壓 By Air Cylinder	5	1	200	255x127x118
NS-5610-900	900		12					254x156x116

B

### NS-5630-700

油壓平面式粘 合 機  
Hydraulic Fusing Machine



操作 中  
In working

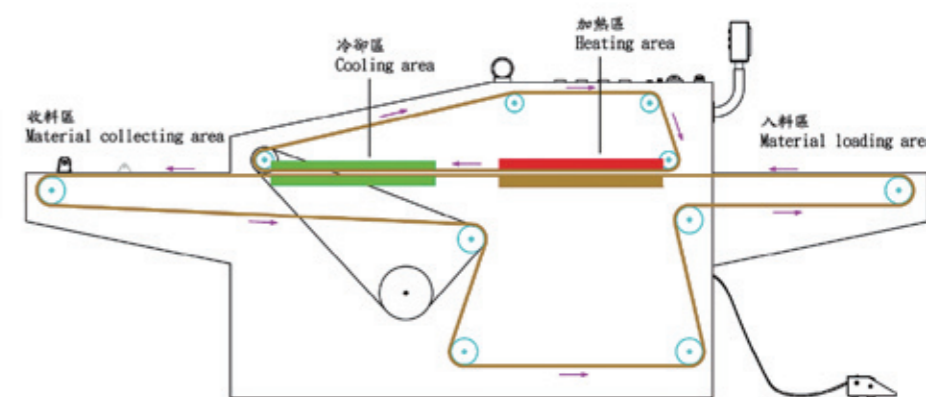

型號 Model	電源 Power Supply	總功率 Total Power(kW)	制冷組件功率 Power of Freezing Assembly(kW)	油泵功率 Oil Pump Power(kW)	加壓方式 Pressure Increasing Mode	增壓壓力 Increasing Pressure (kgf/cm <sup>2</sup> )	平均粘合壓力 Average Fusing Pressure (kgf/cm <sup>2</sup> )	工作臺面尺寸 Working Table Size(mm)	機身尺寸(cm) Machine Size
NS-5630-700	3PH/380V/50Hz	9.2	0.75	2.25	油缸加壓 By Oil Cylinder	100	5	700x550	129x309x129



B

### NS-9205

自動前筒粘合機  
Automatic Placket Fusing Machine



前筒粘合作  
Shirt front placket fusing

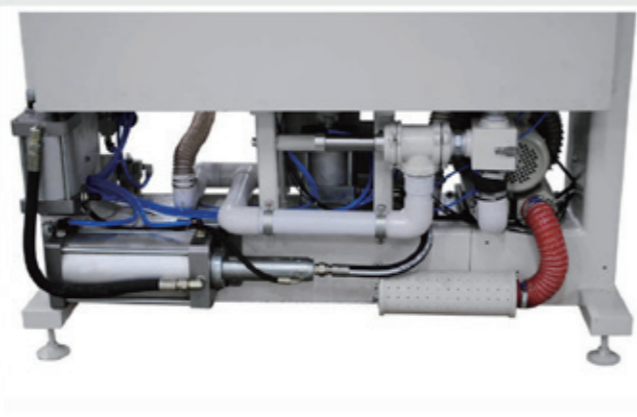

增壓系統  
Pressure boosting system

型號 Model	電源 Power Supply	總功率 Total	加壓方式 Pressure Increasing Mode	壓縮空氣壓力 Compressed Air Pressure (kgf/cm <sup>2</sup> )	增壓壓力 Increasing Pressure (kgf/cm <sup>2</sup> )	平均粘合壓力 Average Fusing Pressure (kgf/cm <sup>2</sup> )	耗壓縮空氣量 Compressed Air Consumption (L/min)	工作臺面尺寸 Working Table Size(mm)	機身尺寸 Machine Size(cm)
NS-9205	3PH/380V/50Hz	7	增壓缸加壓 By Pressure Booster	5	80	5	150	1000x254	150x167x160

B

### NS-5620

油壓平面式粘合機  
Hydraulic Plane Fusing Machine



NS-5620 工作中  
In working



物料架  
Material stand

型號 Model	電源 Power Supply	總功率 Total Power	加壓方式 Pressure Increasing Mode	壓縮空氣壓力 Compressed Air Pressure (kgf/cm <sup>2</sup> )	工作臺面尺寸 Working Table Size(mm)	平均粘合壓力 Average Fusing Pressure (kgf/cm <sup>2</sup> )	耗壓縮空氣量 Compressed Air Consumption (L/min)	機身尺寸 Machine Size(cm)
NS-5620	3PH/380V/50Hz	10.1	增壓缸加壓 By Pressure Booster	5	800x430	5	172	146x164x172



B

### NS- 8933

自動雙頭粘合機  
Automatic Double Buck Fusing Press

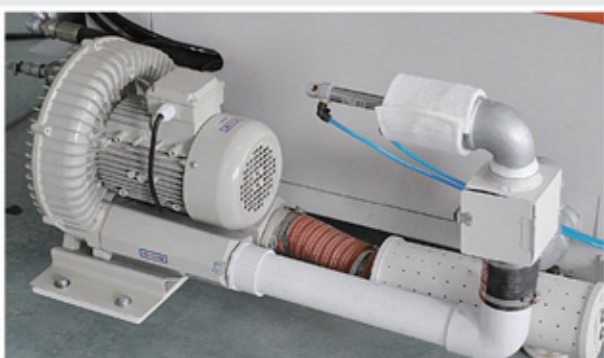

獨立抽風泵  
Equipped with independent vacuum pump



雪佛龍壓布架可將布片固定，防止旋轉時造成移位  
Teflon fabric holding frame can hold the fabric in position to prevent it from moving during rotation

型號Model	電源 Power supply	總功率 Total Power (kW)	加壓方式 Pressure Increasing Mode	壓縮空氣壓力 Compressed Air Pressure (kgf/cm <sup>2</sup> )	平均粘合壓力 Average Fusing Pressure (kgf/cm <sup>2</sup> )	工作臺面尺寸 Working Table Size(mm)	機身尺寸 Machine Size (cm)
NS-8933-H	3PH/380V/50Hz	11.5	增壓缸加壓 By Pressure Booster	5	5	800x400	166x196x160
NS-8933-S						1000x320	
NS-8933-L						1000x500	
NS-8933-A						1400x320	199x234x160
NS-8933-XL						1300x700	166x196x160*

B

### NS- 8934

自動三頭粘合壓平機  
Automatic Triple-Buck Fusing Press

三下模旋轉設計，可同時進行壓熨、冷卻定型、擺料三步操作，大大提高工作效率

Three lower moulds enable you to place, press and cool down the fabric at the same time, so the working efficiency has been improved greatly.

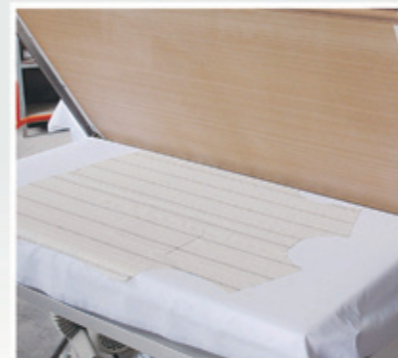

壓前幅  
Pressing shirt front

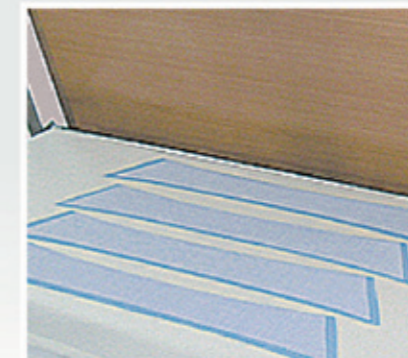

壓領  
Pressing collar

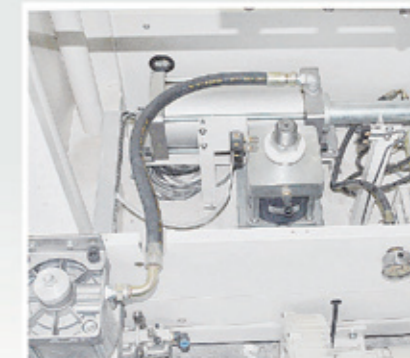

增壓系統  
Pressure booster

型號 Model	電源 Power Supply	總功率 Total Power(kW)	加壓方式 Pressure Increasing Mode	壓縮空氣壓力 Compressed Air Pressure(kgf/cm <sup>2</sup> )	平均粘合壓力 Average Fusing Pressure (kgf/cm <sup>2</sup> )	工作臺面尺寸 Working Table Size(mm)	機身尺寸 Machine Size(cm)
NS-8934	3PH/380V/50Hz	11.5	增壓缸加壓 By Pressure Booster	5	5	800x400	217x202x155
NS-8934-L						1000x500	262x237x162





**NS-42**

反領針機  
Turn Collar Needle  
Machine



**NS-75**

切領咀機  
Collar Point Trimming  
Machine



**NS-44**

反領機  
Collar Turning and  
Blocking Machine



NS-44反領操作  
Collar turning

**NS-76A**

切領咀反領機  
Collar Point Trimming  
and Turning Machine



**NS-76B**

切領咀反領機  
Collar Point Trimming  
and Turning Machine



**NS-80**

熨領角機  
Collar Pressing  
Machine



NS-80熨領操作  
Collar pressing

型號 Model	壓縮空氣壓力(kg/cm <sup>2</sup> ) Compressed Air Pressure	耗壓縮空氣量(L/min) Compressed Air Consumption	淨重(kg) Net Weight	毛重(kg) Gross Weight	機身尺寸(cm) Machine Size
NS-42	---	---	20	30	41x43x107
NS-75	5	10	42	62	76x50x103
NS-76A		15*	36*	62*	66x45x123
NS-76B		15	43	78	76x52x87

型號 Model	電源 Power Supply	總功率(KW) Total Power	壓縮空氣壓力(kg/cm <sup>2</sup> ) Compressed Air Pressure	毛重(kg) Gross Weight	機身尺寸(cm) Machine Size
NS-44	1PH/220V/50Hz	1	—	100	66x55x117
NS-80		0.9	5		84x59x139



### NS-53P

自動反領焗領機  
Automatic Retractable Collar Turning  
and Blocking Machine



### NS-89P

自動切領咀反領焗領機  
Automatic Collar Trimming Turning  
and Blocking Machine

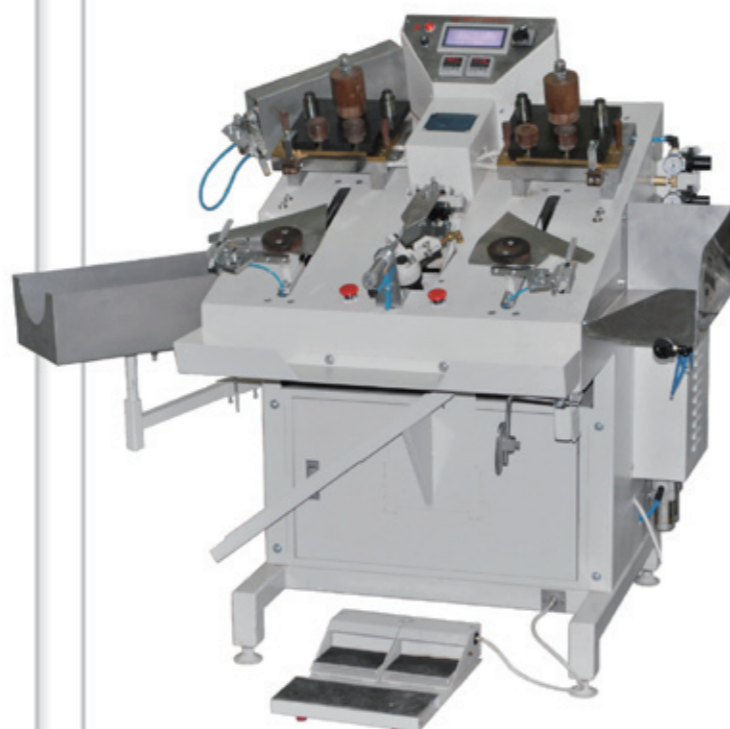

### NS-81P

自動切領咀反領焗領機  
Automatic Collar Trimming,  
Turning and Blocking Machine



選購模(Optional moulds) :

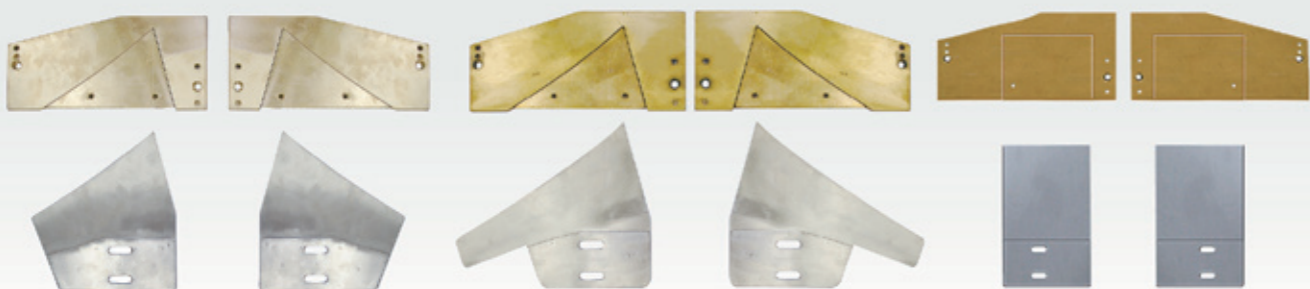

NS-53P領模(適合壓熨領尖)  
Collar mould  
(for pressing collar point)

NS-89領模(適合壓熨領尖)  
Collar mould  
(for pressing collar point)

NS-89袋蓋模  
Pocket flap mould

選購模(Optional moulds) :

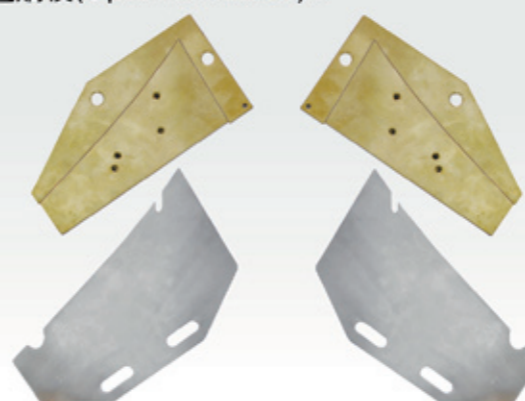

NS-81P領模(適合壓熨整條領)  
Collar mould(for pressing the whole collar)



NS-81P 切領操作  
Collar cutting operation

型號 Model	電源 Power Supply	發熱線功率(kW) Heater Power	壓領最長(inch) Max. Pressing Length	淨重(kg) Net Weight	毛重(kg) Gross Weight	機身尺寸(cm) Machine Size	裝箱尺寸(cm) Packing Size
NS-53P	1PH/220V/50Hz	1	6	159	252	82x87x126	102x99x142
NS-89P		2		280	350	138x100x126	115x117x140

型號 Model	電源 Power Supply	發熱線功率(kW) Heater Power	壓領最長(inch) Max. Pressing Length	淨重(kg) Net Weight	毛重(kg) Gross Weight	機身尺寸(cm) Machine Size	裝箱尺寸(cm) Packing Size
NS-81P	1PH/220V/50Hz	2.6	8 $\frac{1}{2}$	240	131x95x118	138x100x126	115x117x140



### NS-82P

自動燭領機  
Automatic Collar Blocking Machine



### NS-87P

自動切領咀反領燭領機連左右機械手  
Automatic Collar Trimming, Turning and Blocking Machine with Left & Right Automatic Arm



### NS-88P

自動切領咀反領燭領機連左右機械手及左收料架  
Automatic Collar Trimming, Turning and Blocking Machine with Left & Right Automatic Arm & Left Stacker



NS-82P 工作中  
In working

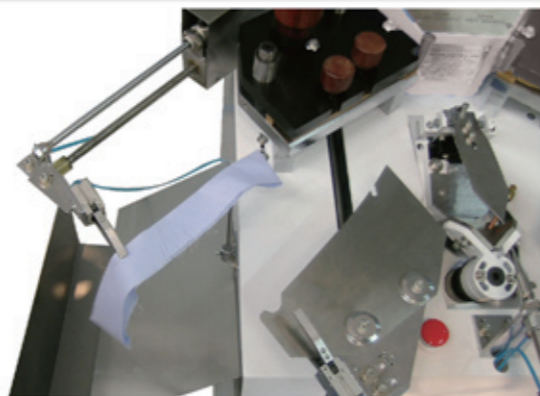

機械手自動收料  
Automatic arm for stacking automatically



PLC 控制面板  
PLC Control Panel

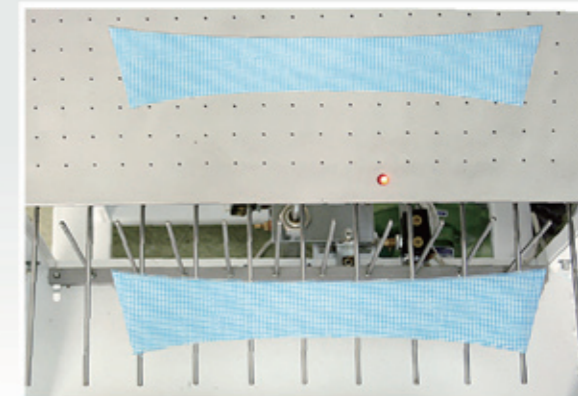

NS-88P 左收料架，自動收、疊料  
Left stacker for collecting and stacking material automatically

型號 Model	電源 Power Supply	總功率(kW) Total Power	壓領最長(inch) Max Pressing Length	淨重(kg) Net Weight	裝箱尺寸(cm) Packing Size
NS-82P	1PH/220V/50Hz	2.7	8½	178	104x112x138
NS-87P				192	

型號 Model	電源 Power Supply	總功率(kW) Total Power	壓領最長(inch) Max Pressing Length	淨重(kg) Net Weight	裝箱尺寸(cm) Packing Size
NS-88P	1PH/220V/50Hz	2.7	8½	203(主機 main machine body)	112x112x129
				70(收料架 stacker)	98x75x108



### NS-95

氣動點領機(刀印)  
Pneumatic Collar Notcher(cutting mark)



### NS-95A

氣動點領機  
Pneumatic Collar Notcher



### NS-96

領彎邊打扼機  
Collar Curve Edge Notcher

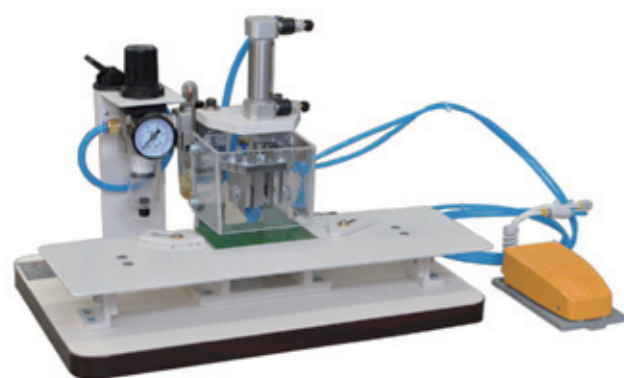

### NS-96A

領彎邊打扼機  
Collar Curve Edge Notcher

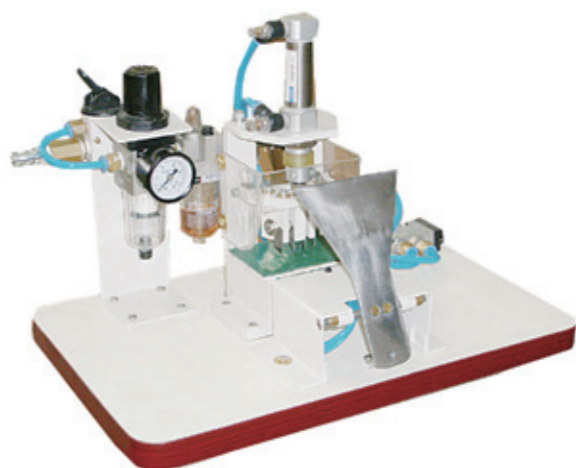

型號 Model	壓縮空氣壓力(kgf/cm <sup>2</sup> ) Compressed Air Pressure	耗壓縮空氣量(L/min) Compressed air consumption	淨重(kg) Net Weight	毛重(kg) Gross Weight	機身尺寸(cm) Machine Size
NS-95	5	10	12	15	43x30x29
NS-95A			14	17	43x33x40
NS-96			8	10	39x26x27
NS-96A					40x26x28

### NS-100-1

領咀鈕模打孔送模器  
Collar Down Button Lining Feeding Punching Device



跟機模為(standard mould) :  
打模模組合(模頭帶三個槽口)  
O-C-03-02-12(Ø12mm)  
Lining punching mould set(mould head with 3 notches)

#### 選購件Options :

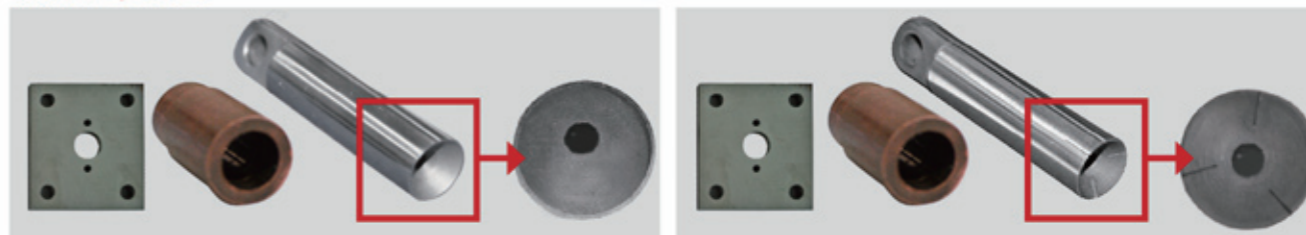

#### 1. 打布模組合(模頭無槽口)

Fabric punching mould set(mould head without notch)  
三種規格供選購(three kinds of specification for option) :  
O-C-03-01-08(Ø8mm); O-C-03-01-10(Ø10mm);  
O-C-03-01-12(Ø12mm)

#### 2. 打模模組合(模頭帶三個槽口)

Lining punching mould set(mould head with 3 notches)  
兩種規格供選購(two kinds of specification for option)  
O-C-03-02-08(Ø8mm); O-C-03-02-10(Ø10mm)



布 Fabric



模 Lining

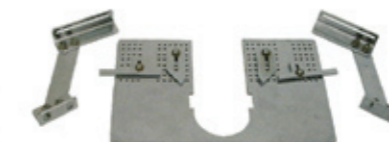

3.A604-CS-BL 釘領咀鈕盤  
Collar Down Button Stitch Gauge

NS-100-1安裝在縫紉機上  
Being installed on a sewing machine

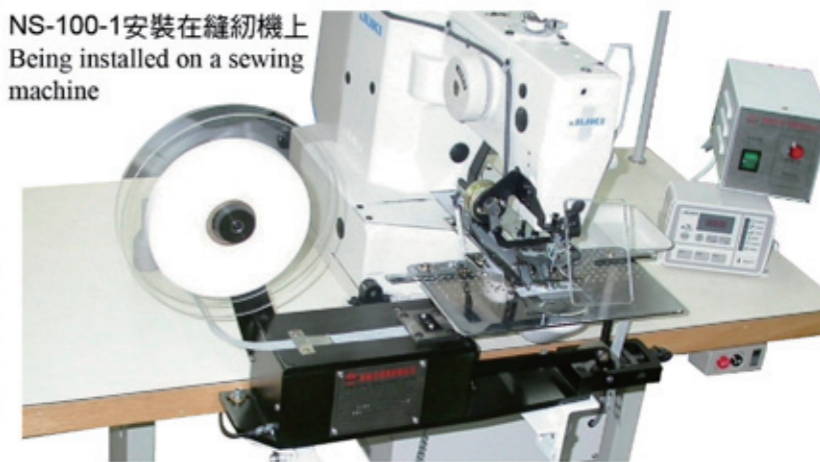

型號 Model	電源 Power Supply	馬達功率 Motor Power(kW)	淨重(kg) Net Weight	毛重(kg) Gross Weight	裝箱尺寸(cm) Packing Size
NS-100-1	1PH/220V/50Hz	0.2	18	19.5	61x19x33



### NS-85LP

自動燭袖口機  
Automatic Cuff Blocking Machine



### NS-85P

自動燭袖口機  
Automatic Cuff Blocking Machine



### NS-46

袖口機  
Cuff Turning and Blocking Machine

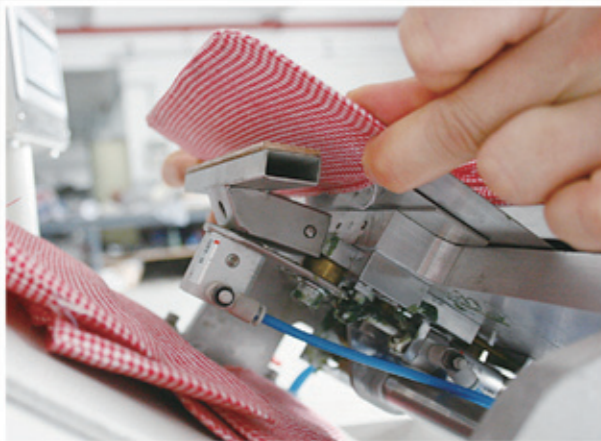

NS-85P自動底夾，防止操作時袖口移位  
Automatic bottom clamp for avoiding cuff shift during operation



NS-85LP採用面夾，可整理紙口  
Adopt surface clamp for easy tidying the margin



NS-85P操作中  
In working

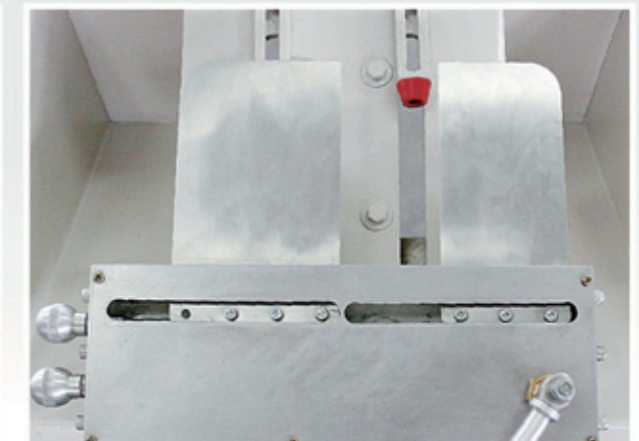

NS-46袖口模板寬度可調  
The width of cuff mould can be adjusted

型號 Model	電源 Power Supply	總功率(kW) Total Power	最大袖口長度 (inch) Max. Cuff Length	壓縮空氣壓力(kgf/cm <sup>2</sup> ) Compressed Air Pressure	耗壓縮空氣量(L/min) Compressed Air Consumption	機身尺寸(cm) Machine Size
NS-85LP	1PH/220V/50Hz	4.2	16½	5	80	78x104x123

型號 Model	電源 Power Supply	總功率(kW) Total Power	袖口最大長度(inch) Max. Cuff Length	壓縮空氣壓力(kgf/cm <sup>2</sup> ) Compressed Air Pressure	耗壓縮空氣量(L/min) Compressed Air Consumption	淨重(kg) Net Weight	機身尺寸(cm) Machine size
NS-46	1PH/220V/50Hz	1	13	—	—	70	53x64x117
NS-85P		2		5	80	152	73x97x130



### NS-9084S-N

自動風壓蒸汽摺袋機-單頭  
Pneumatic Steam Pocket Creasing Machine-  
Single Head



### NS-9084S-ND

自動風壓蒸汽摺袋機-雙頭  
Pneumatic Steam Pocket Creasing Machine-  
Double Head



### NS-9083S-N

針織龜背貼摺熨機 — 單頭  
(采用鐳射燈定位)  
Knit Back Patch Creasing Machine –  
Single Head(with laser marker for positioning)



### NS-41

四邊摺袋蓋機  
Pocket Flap Creasing  
Machine



### NS-43

摺袋機  
Pocket Creasing  
Machine

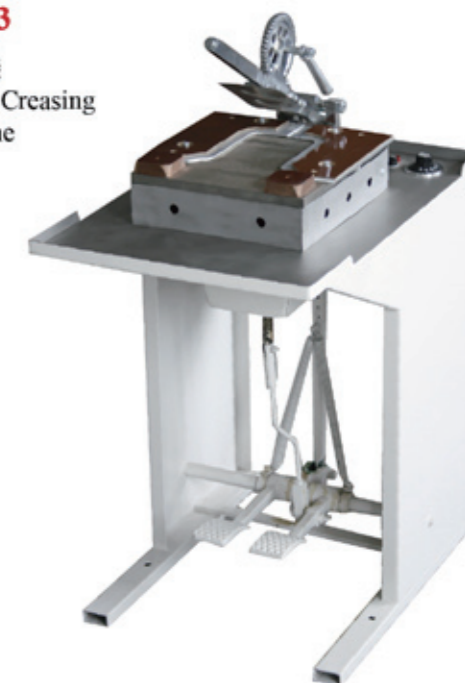

摺袋工作  
Pocket creasing

選購件(options) :

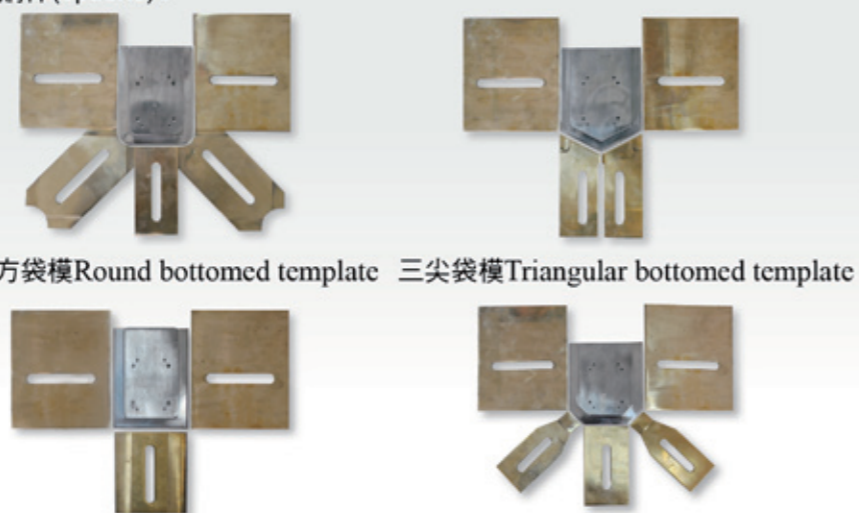

圓方袋模Round bottomed template 三尖袋模Triangular bottomed template

四方袋模Square bottomed template 六角袋模Hexagon bottomed template

型號 Model	電源 Power Supply	總功率(KW) Total Power	摺袋尺寸(inch) Size of creased pocket		壓縮空氣壓力(kgf/cm <sup>2</sup> ) Compressed Air Pressure	蒸汽壓力(kgf/cm <sup>2</sup> ) Steam Pressure
NS-9084S-N	1PH/220V/50Hz	1.3	W: 3¼ ~ 7½	L: 5~8	5	3 (需外接蒸汽 Need to prepare external steam supply)
NS-9084S-ND		2.5				
NS-9084S-L		1.9				
NS-9084S-LD		3.7	W: 4¼ ~ 9½	L: 5~10		

龜背模  
Back patch template



型號 Model	電源 Power Supply	總功率 Total Power(kW)	摺袋尺寸(inch) Size of creased pocket		淨重(kg) Net Weight	機身尺寸(cm) Machine Size
NS-41	1PH/220V/50Hz	1	W: 3¼~6¼	L: 4~8	70	49x69x104
NS-41-L			W: 4¼~10	L: 5~10	76	49x69x110
NS-43			W: 5~7½	L: 3¼~6½	66	49x69x104
NS-43-L			W: 5¼~10½	L: 4¼~9¼	74	49x69x112
NS-9083S-N			1.3*	W: 3¼~7¼	L: 5~8	107*
NS-9083S-ND	2.6*	255*	141x102x118*			



### NS-92

修領腳機  
Collar Contour Trimmer



### NS-94-1

修筒車  
Placket Cutting Machine



### NS-94AC-1

自動收料修筒車  
Placket Cutting Machine with Automatic Stacker

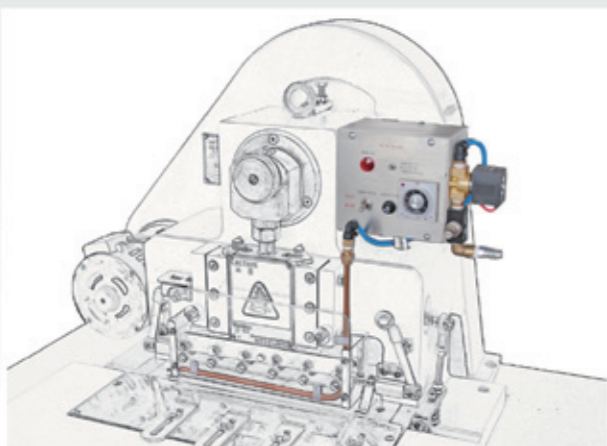

選購件：吹氣系統  
Option: Air blowing system

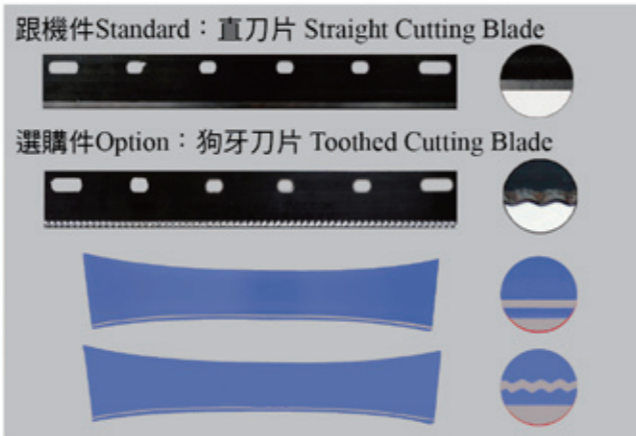

跟機件Standard：直刀片 Straight Cutting Blade  
選購件Option：狗牙刀片 Toothed Cutting Blade  
修領效果  
Collar trimming result

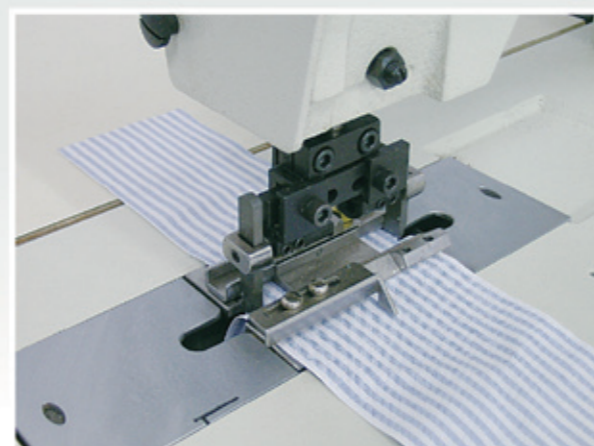

NS-94-1/NS-94AC-1專用於前胸筒對中線用  
Designed for matching center line of shirt placket



NS-94AC-1 電眼感應自動收料  
Automatically material stacking by photoelectric sensing

型號 Model	電源 Power Supply	總功率(kW) Total Power	馬達(kW) Motor	最大裁切長度(inch) Max. Cutting Length	機身尺寸(cm) Machine Size
NS-92L	1PH/220V/50Hz	0.3	0.25	10	92x59x130
NS-92H				14	

型號 Model	電源 Power Supply	工作寬度(inch) Work Width	淨重(kg) Net Wt.	毛重(kg) Gross Wt.	機身尺寸(cm) Machine Size
NS-94-1	1PH/220V/50Hz	1½ ~ 2½	88	140	108x58x107
NS-94-W		2½ ~ 4	81	134	
NS-94AC-1		1½ ~ 2½	113	165	108x67x107
NS-94AC-W		2½ ~ 4		167	



### NS-5503

側袖摺熨機  
Sleeve Placket Folding and Ironing Machine

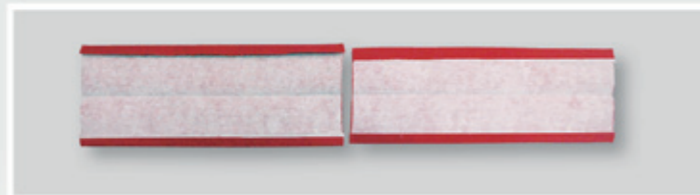

NS-5503 半胸明筒  
Polo placket

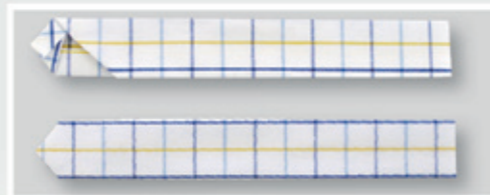

NS-5503 三尖側貼  
Triangular sleeve placket

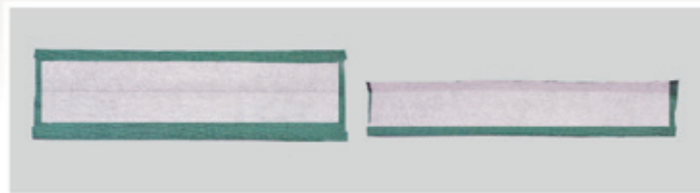

NS-5503 蚊雞筒  
Patch placket



NS-5503 四方三尖側貼  
Square sleeve placket

型號 Model	電源 Power Supply	總功率(kW) Total Power	壓縮空氣壓力(kg/cm <sup>2</sup> ) Compressed Air Pressure	耗壓縮空氣量(L/min) Compressed Air Consumption	機身尺寸(cm) Machine Size
NS-5503	3PH/380V/50Hz	5.6	5	95	92x134x162

### NS-5504

真空摺熨機  
Vacuum Folding and Ironing Machine



NS-5503  
鐳射燈精確定位  
Laser light for positioning



NS-5504三尖半胸筒  
Triangular front placket



NS-5504四方嘜頭貼  
Square label



NS-5504三角嘜頭貼  
Triangular label

型號 Model	電源 Power Supply	總功率(kW) Total Power	壓縮空氣壓力(kg/cm <sup>2</sup> ) Compressed Air Pressure	耗壓縮空氣量(L/min) Compressed Air Consumption	機身尺寸(cm) Machine Size
NS-5504	3PH/380V/50Hz	8.8	5	95	131x121x171





### NS-5502

前筒摺熨機  
Front Placket Folding Machine



操作中(帶模) Operation with interlining



鐳射燈定位，精確對條、對格  
Laser marker for more accurate stripe and check matching



選購件：右切筒模器  
(編號 code: O-C-01-3)  
Option: Right placket interlining cutting device(code: O-C-01-3)

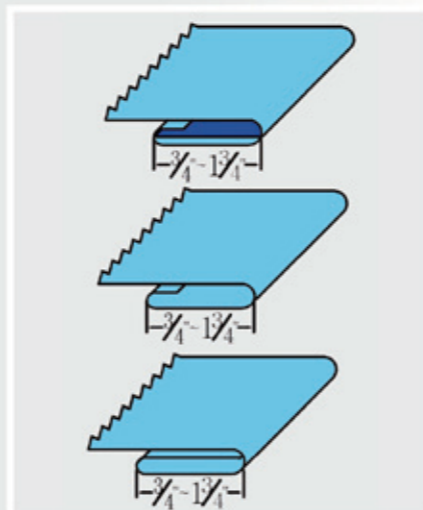

以上尺寸範圍中：  
1", 1 1/8", 1 3/16", 1 1/4", 1 1/2" 共五款模為跟機模，  
3/4", 7/8", 1 1/8", 1 3/8", 1 1/2" 為選購模。  
可摺熨的前筒類型  
Front placket folding types

型號 Model	電源 Power Supply	總功率(kW) Total Power	壓縮空氣壓力(kgf/cm <sup>2</sup> ) Compressed Air Pressure	耗壓縮空氣量(L/min) Compressed Air Consumption	淨重(kg) Net Weight	機身尺寸(cm) Machine Size
NS-5502	3PH/380V/50Hz	9.5	5	200	500	139x137x184

### NS-2410

轉熨機  
Rotary Pressing Machine



### NS-2411

轉熨機  
Rotary Pressing Machine

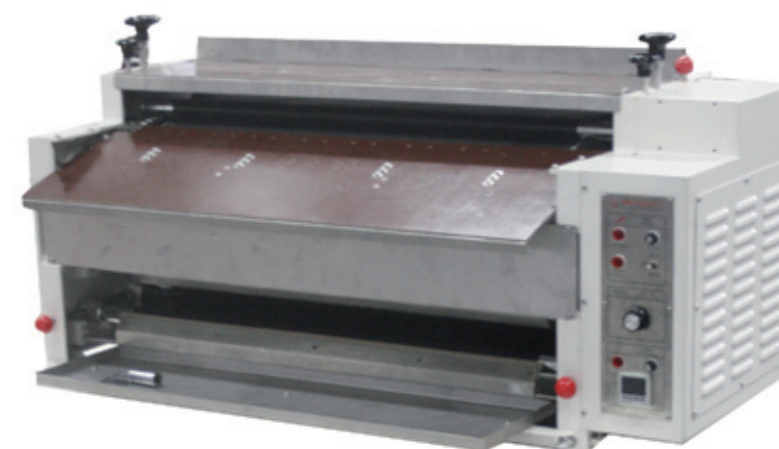

可附裝各種袋模及蝴蝶作摺熨用  
Can be equipped with attachment for ironing and folding purpose  
注：蝴蝶為選購件  
Notes: Folders are optional parts



F-538 三尖側貼蝴蝶  
Triangular Sleeve Placket Folder  
F-540 三尖側貼蝴蝶  
Triangular Sleeve Placket Folder  
F-542 摺衫腳縫三角蝴蝶  
Shirt Bottom Side Seam Triangle Folder



NS-2410/NS-2411 三尖側貼  
Triangular sleeve placket

型號 Model	電源 Power Supply	總功率(kW) Total Power	發熱線功率(kW) Heater Power	工作寬度(mm) Work Width	最高設計溫度(°C) Max. Design Temp.	機身尺寸(cm) Machine Size
NS-2410	1PH/220V/50Hz	2.7	2.5	400	200	85x71x61
NS-2411		3.2	3	800		130x90x61



### NS-6039-1 NS-6039-2

自動夾模縫紉機  
Automatic Pattern Sewer

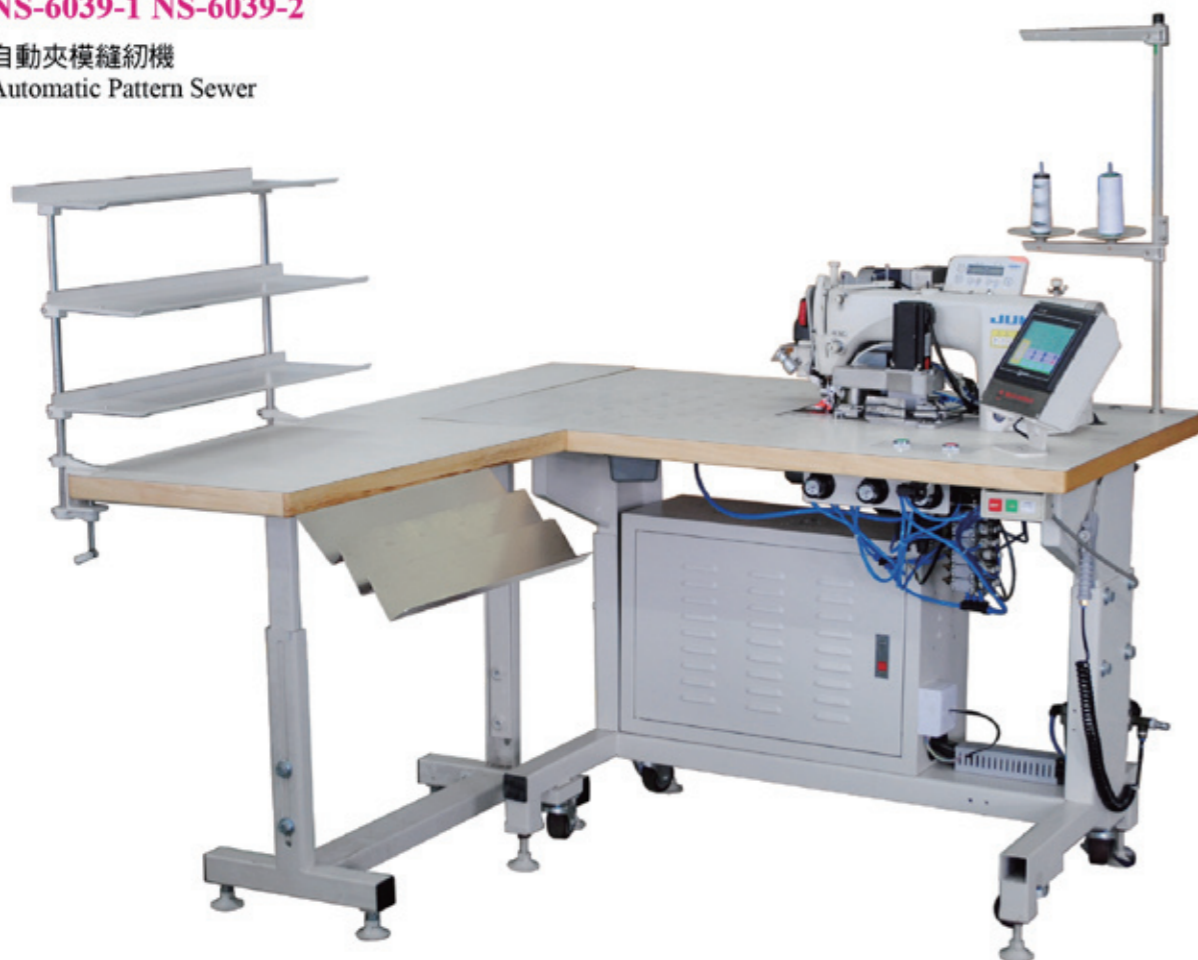

- NS-6039-1/NS-6039-2 適用於自動車縫領、袖口、袋蓋等恤衫裁片 suitable for sewing cut piece of shirt collar, cuff, pocket flap, etc.
- NS-6039-2 特別適合縫製男女西裝內襟等寬大的裁片 specially suitable for sewing broad cut piece of men's and women's suit lapel

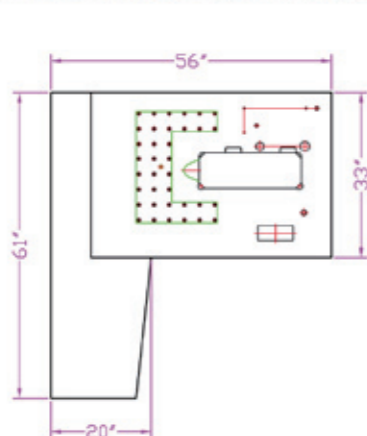

NS-6039-1  
工作臺面 Working table size

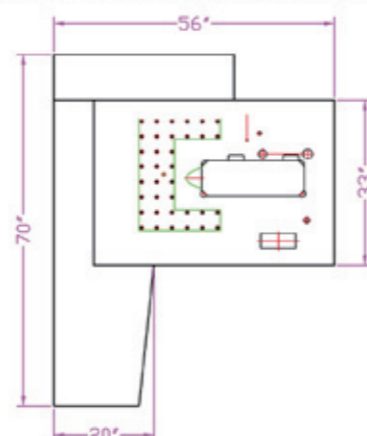

NS-6039-2  
工作臺面 Working table size

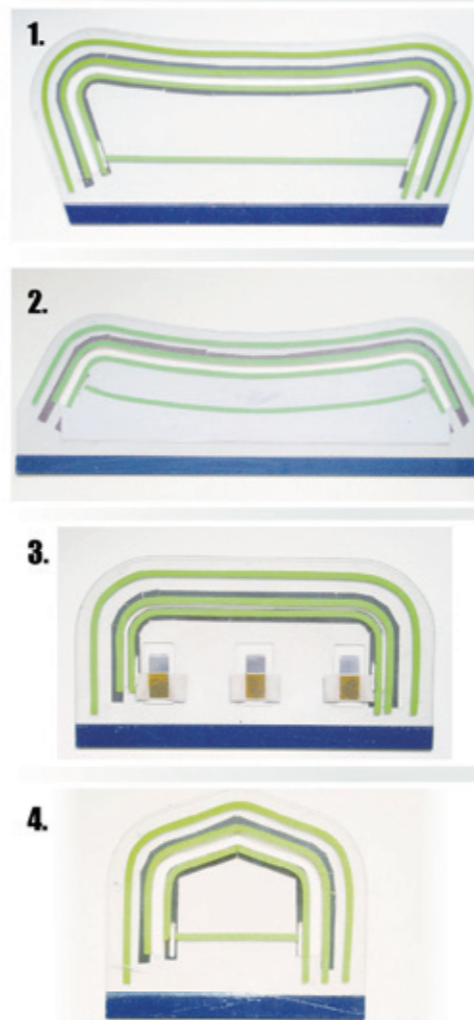

#### 選購件

1. 上級領模
2. 下級領模
3. 圓角介英模
4. 袋蓋模

#### Options:

1. Upper collar stitch jig
2. Collar band stitch jig
3. Round corner cuff stitch jig
4. Pocket flap stitch jig

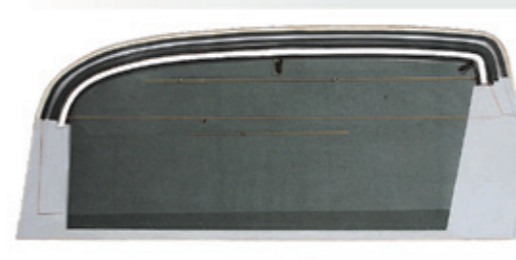

NS-6039-2 男裝西裝內襟夾模  
Man's suit lapel stitch jig  
最大夾模尺寸：85 x 40cm  
Max. size of stitch jig: 85 x 40cm

### NS-101

縫紉夾鑿坑機  
Stitch Profile Clamp Milling Machine



注：NS-101專用於NS-6039-1 NS-6039-2所需模具加工  
Note: NS-101 is specially designed for making patterns which will be used by the machines of NS-6039-1 and NS-6039-2



NS-101製作袖口模型中  
Making cuff stitch jig

型號 Model	電源 Power Supply	總功率(kW) Total Power	工作臺面尺寸(Inch) Working Table Size(LxW)	配用縫紉機 Sewing Machine to be Matched	車縫最大速(RPM) Max. Sewing Speed	淨重(kg) Net Weight	機身尺寸(cm) Machine Size
NS-6039-1	1PH/220V/50Hz	0.8	56"x61"	重機 JUKI DDL-9000B-SS	4000	136"	144x156x156
NS-6039-2			56"x70"			140"	144x178x156

型號 Model	電源 Power Supply	總功率(kW) Total Power	鑽銑刀規格(mm) Drilling Milling Cutter Spec.	淨重(kg) Net Weight	機身尺寸(cm) Machine Size
NS-101	1PH/220V/50Hz	0.93	Ø4    Ø11	70	107x54x111



# 自動縫紉設備及收料架

## Shirt Auto-Sewing Equipment and Stackers

### NS-6034

自動鈕門機連收料架  
Automatic Button Hole Machine with Stacker



注：不含衣車頭  
Not including sewing head



人性化操作界面  
User friendly touch screen



效果圖  
Finished result

型號 Model	適用衣車頭機型 Model of the Sewing M/c to be matched	電源 Power Supply	總功率(kW) Total Power	壓縮空氣壓力(kgf/cm <sup>2</sup> ) Compressed Air Pressure	耗壓縮空氣量(L/min) Compressed Air Consumption	機身尺寸(cm) Machine Size
NS-6034	JUKI LBH-1790 或 or Brother HE-800B	3PH/380V/50Hz	2.7	5	10*	192x87x156



NS-6034 工作中 In working

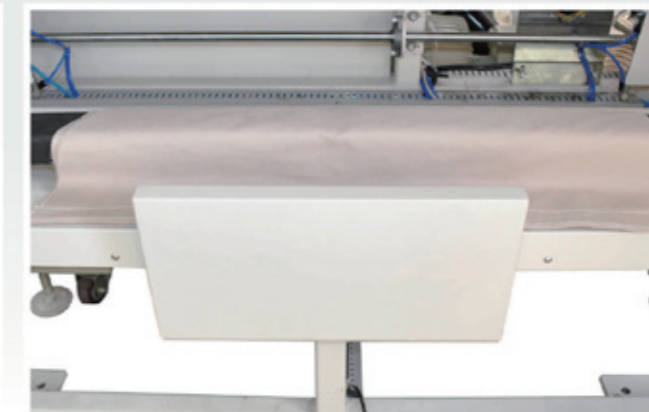

NS-6034 收料完成 Stacking finished

### NS-6041

襯衫切筒機連收料架  
Shirt Placket Interlining Cutting Machine with Stacker



注：不含衣車頭  
Not including sewing head

NS-6041 工作中 In working

型號 Model	電源 Power Supply	總功率(kW) Total Power	壓縮空氣壓力(kgf/cm <sup>2</sup> ) Compressed Air Pressure	耗壓縮空氣量(L/min) Compressed Air Consumption	機身尺寸(cm) Machine Size
NS-6041	3PH/380V/50Hz	0.2	5	8	192x101x96



### NS-6001-1

襯衫前幅鈕子收料架  
Shirt Front Button Stacker

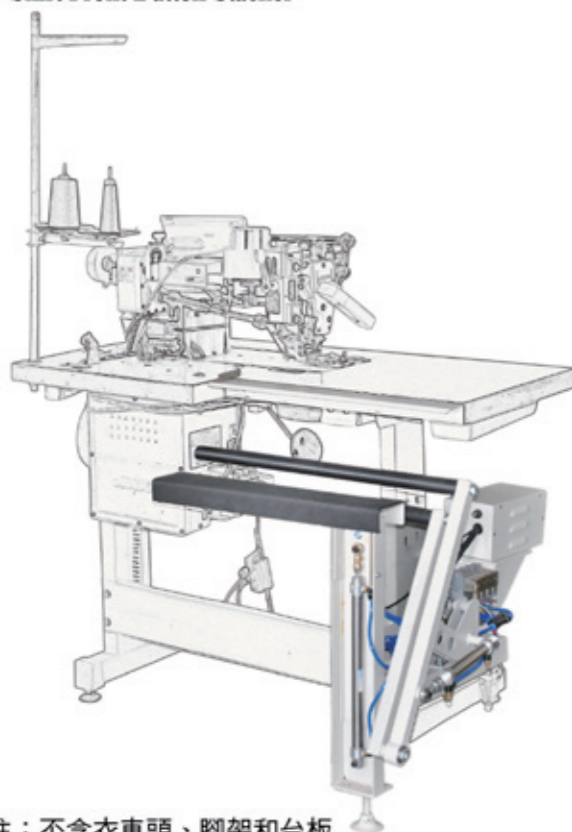

注：不含衣車頭、腳架和台板  
Not including sewing head, machine foot and table top

### NS-6021-1

襯衫前幅鈕子切模器連收料架  
Shirt Front Button Interlining Cutting Device with Stacker

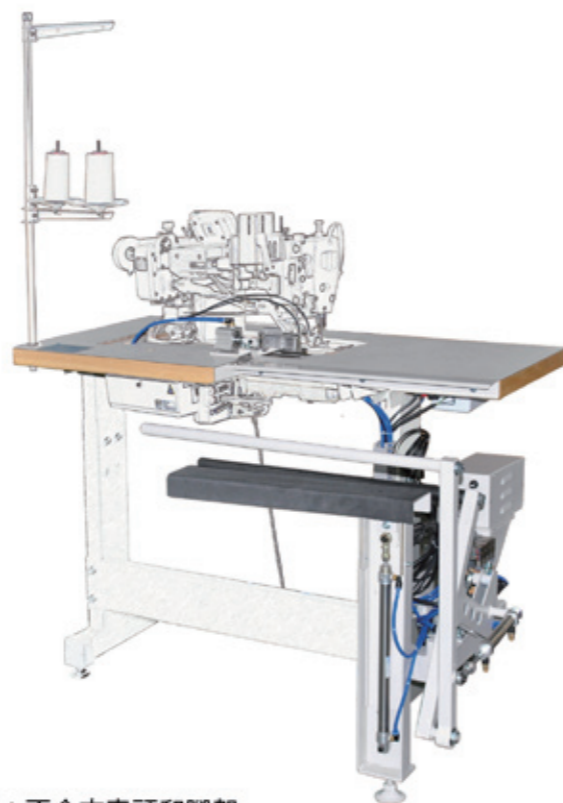

注：不含衣車頭和腳架  
Not including sewing head and machine foot

### NS-6002-1

襯衫前幅鈕筒切模器連收料架  
Shirt Front Button Placket Interlining Cutting Device with Stacker



注：不含衣車頭  
Not including sewing head

### NS-6022-1

襯衫前幅鈕筒切模器連收料架  
Shirt Front Button Placket Interlining Cutting Device with Stacker

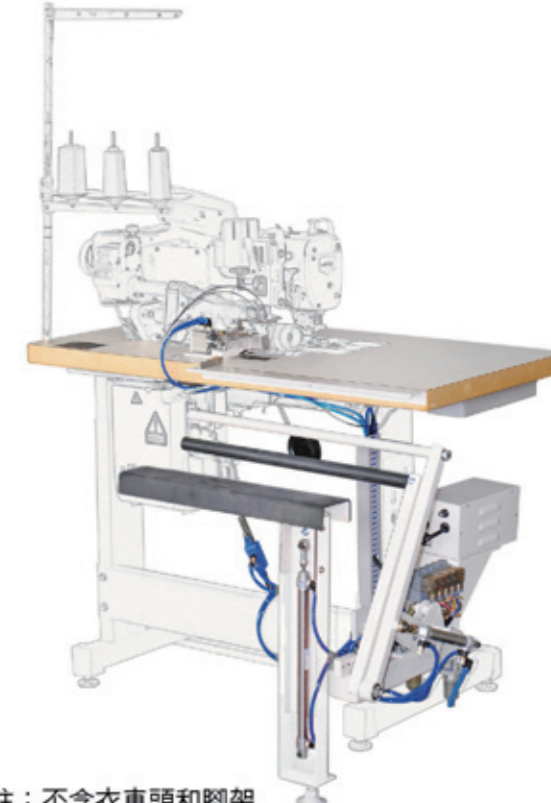

注：不含衣車頭和腳架  
Not including sewing head and machine foot

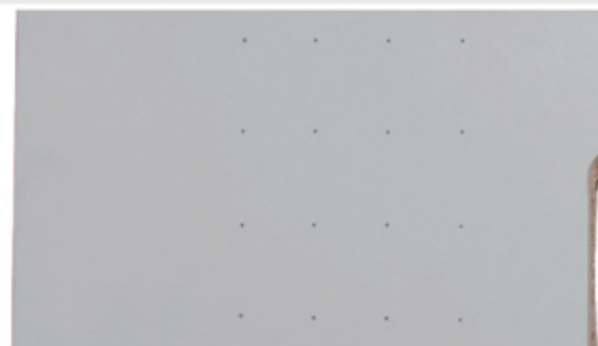

NS-6001-1 吹風臺面 Air-blowing table top  
單針平縫車用  
For single needle lockstitch machine



NS-6021-1 適用於單針平車拉鈕子有模操作；  
電眼控制連切刀操作  
Suitable for single needle lockstitch machine for sewing and cutting button placket with interlining; electric eye control



NS-6002-1 適用於關西筒車；電眼控制連切刀操作  
Suitable for Kansai Yamato, 4 needle chain stitch machine; electric eye control with cutting function



原位取料  
On-site material collection

型號 Model	電源 Power Supply	總功率 Total Power(kW)	壓縮空氣壓力 Compressed Air Pressure(kgf/cm <sup>2</sup> )	耗壓縮空氣量 Compressed Air Consumption(L/min.)	淨重 Net Weight (kg)	機身尺寸 Machine Size (cm)	裝箱尺寸 Packing Size (cm)
NS-6001-1	1PH/220V/50Hz	0.03	5	10	54	114x73x80	130x89x95
NS-6021-1		0.04		12	58		124x83x90*

型號 Model	電源 Power Supply	總功率(kW) Total Power	壓縮空氣壓力 Compressed Air Pressure(kgf/cm <sup>2</sup> )	耗壓縮空氣量 Compressed Air Consumption(L/min.)	淨重 Net Weight (kg)	機身尺寸(cm) Machine Size
NS-6002-1	1PH/220V/50Hz	0.04 (不連衣車頭功率 not include the sewing machine power)	5	6	65	144x156x156
NS-6022-1		5		5	56*	144x178x156



### NS-6009

左側裁片收料架  
Table Left Material Stacker

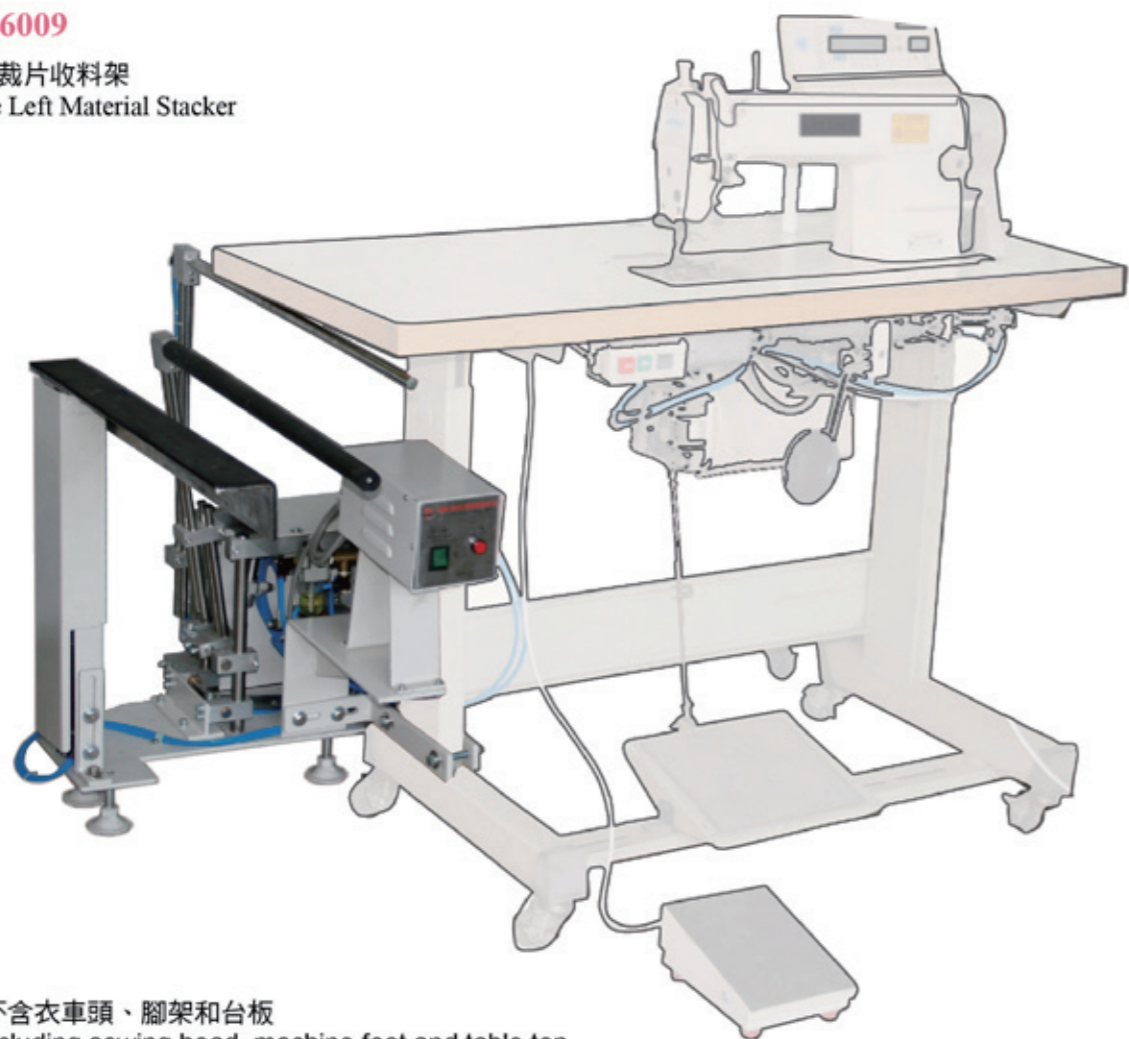

注：不含衣車頭、腳架和台板  
Not including sewing head, machine foot and table top

收料架收料流程圖 Flow chart of material stacking

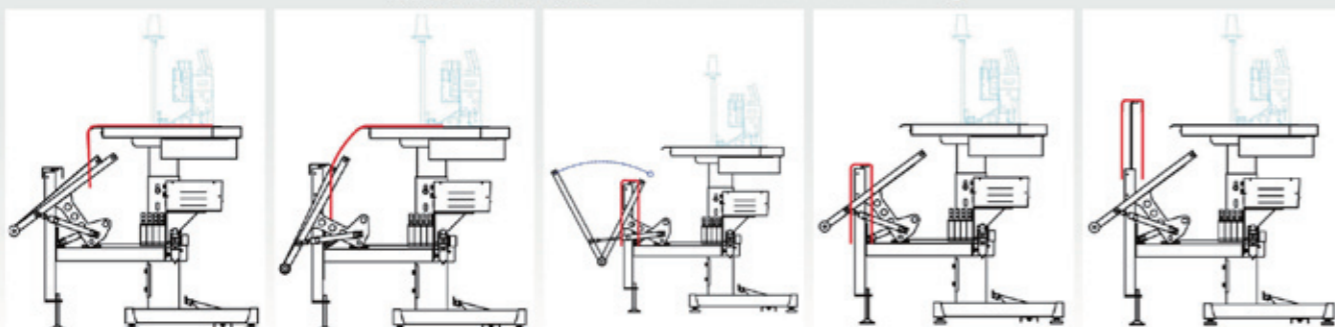

1. 裁片車縫中  
Sewing in process
2. 夾布桿夾布  
Clamping fabric
3. 撥布桿撥布  
Pushing fabric aside
4. 裁片車縫完成  
Sewing finished
5. 收料架升起，方便取料  
Stacker lifts up to collect material

型號 Model	電源 Power Supply	總功率(kW) Total Power	壓縮空氣壓力(kgf/cm <sup>2</sup> ) Compressed Air Pressure	耗壓縮空氣量(L/min) Compressed Air Consumption	淨重(kg) Net Weight
NS-6009	1PH/220V/50Hz	0.04	5	8	26

### NS-6012-1

小裁片收料架  
Small Pieces Stacker



注：不含衣車頭、腳架和台板  
Not including sewing head, machine foot and table top



NS-6012-1 將裁片撥至升料架  
Pull cuff piece to the lifting stand

型號 Model	電源 Power Supply	總功率(kW)(不連衣車頭功率) Total Power(not include the sewing machine power)	壓縮空氣壓力(kgf/cm <sup>2</sup> ) Compressed Air Pressure	耗壓縮空氣量(L/min.) Compressed Air Consumption	機身尺寸(僅收料架)(mm) Machine Size(only stacker)
NS-6012-1	1PH/220V/50Hz	0.1	5	8	600x400x1000
NS-6013		0.03		13	---
NS-6018		0.04		8	630x560x1000

### NS-6013

袖口/下級堆放架  
Cuff/Collar Band Push Clamp

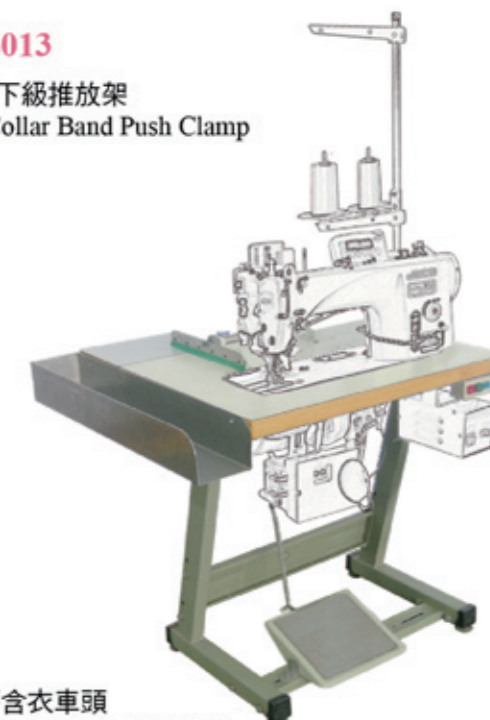

注：不含衣車頭  
Not including sewing head

### NS-6018

檯前推料架  
Front Push Clamp with Table



注：不含衣車頭、腳架和台板  
Not including sewing head, machine foot and table top



### NS-6006

氣動裁片夾  
Pneumatic Material Clip Stand



### NS-6020

活動氣動裁片夾  
Movable Pneumatic Material Clip Stand



### NS-6008

後氣動裁片夾連台面  
Back Pneumatic Material Clip Stand with Table Top

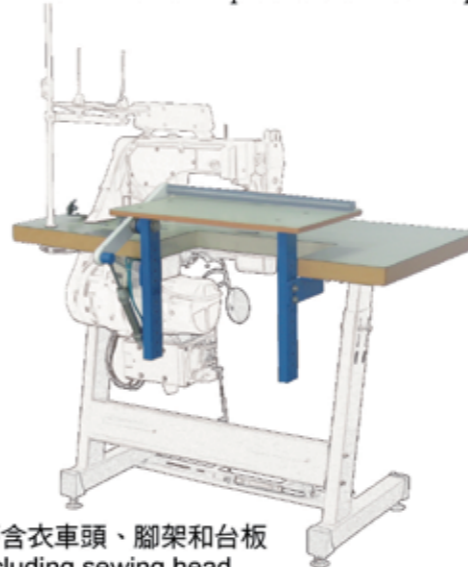

注：不含衣車頭、腳架和台板  
Not including sewing head, machine foot and table top

### NS-6023

袖衩釘鈕夾  
Sleeve Placket Button Stitching Clamp

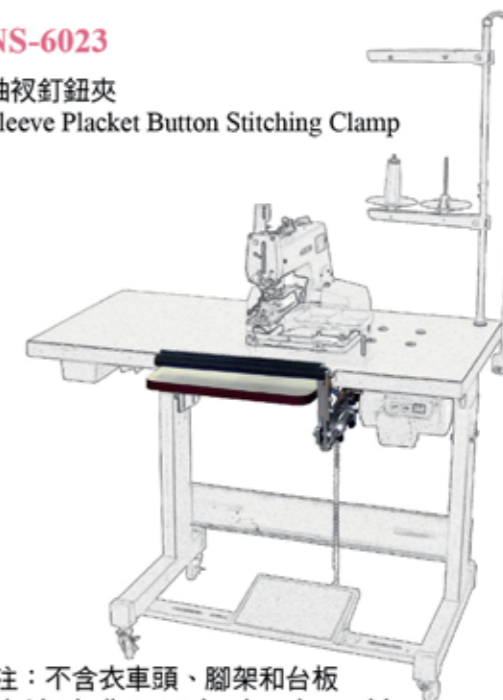

注：不含衣車頭、腳架和台板  
Not including sewing head, machine foot and table top

### NS-6007

吹氣系統  
Air Jet Device

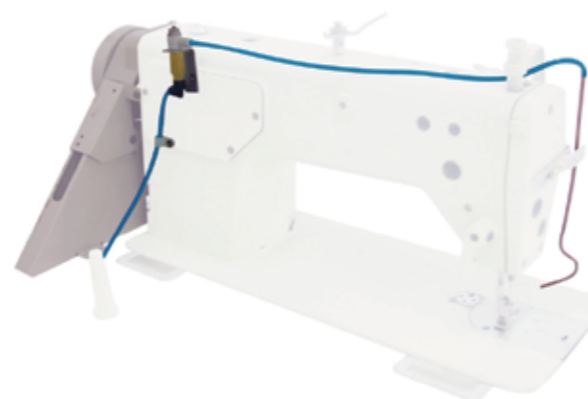

注：不含衣車頭、腳架和台板  
Not including sewing head, machine foot and table top

### NS-6014

2段針距控制器  
Two Stitch Length Device

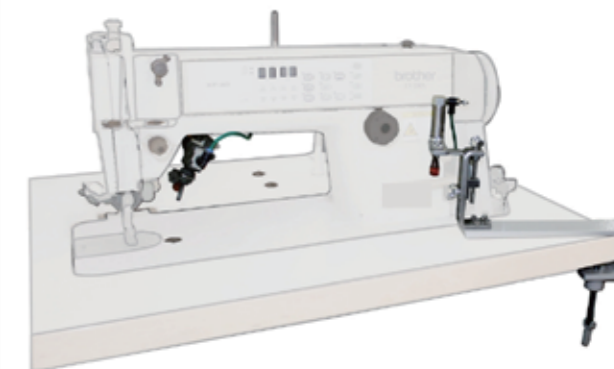

注：不含衣車頭、腳架和台板  
Not including sewing head, machine foot and table top



NS-6006 最適合用於恤衫擔桿及袖側  
Best for shirt yoke and sleeve placket



NS-6020適用於大件的擔桿裁片  
Suitable for big yoke cutting piece



NS-6020工作時，裁片夾可調至與衣車同步令車縫時更順暢，完成後自動回位  
In operation, cutting pieces clip can be adjusted in the same pace with stitch machine, make stitch smooth, after finish it will restore automatically

型號 Model	電源 Power Supply	總功率 Total Power(kW)	壓縮空氣壓力 Compressed Air Pressure(kgf/cm <sup>2</sup> )	耗壓縮空氣量 Compressed Air Consumption(L/min.)	淨重 Net Weight (kg)	毛重 Gross Weight (kg)	機身尺寸 Machine Size (cm)
NS-6006	---	---	5	1	27	47	72x50x79
NS-6020	1PH/220V/50Hz	0.01		3	44	67	76x40x77

型號 Model	電源 Power Supply	總功率(kW) Total Power	壓縮空氣壓力(kgf/cm <sup>2</sup> ) Compressed Air Pressure	耗壓縮空氣量(L/min) Compressed Air Consumption	淨重(kg) Net Weight	機身尺寸(cm) Machine Size
NS-6007	1PH/220V/50HZ	0.01	5	3	0.8	20x6x7
NS-6008	---	---		0.5	31	50x20x43
NS-6014	1PH/220V/50HZ	0.01		0.5	1	42x22x38
NS-6023	---	---		1	---	---



### NS-3600B

電蒸汽熨斗(帶回水管)  
Electric Steam Iron



136 x 206mm

### NS-3601

電蒸汽熨斗  
Electric Steam Iron

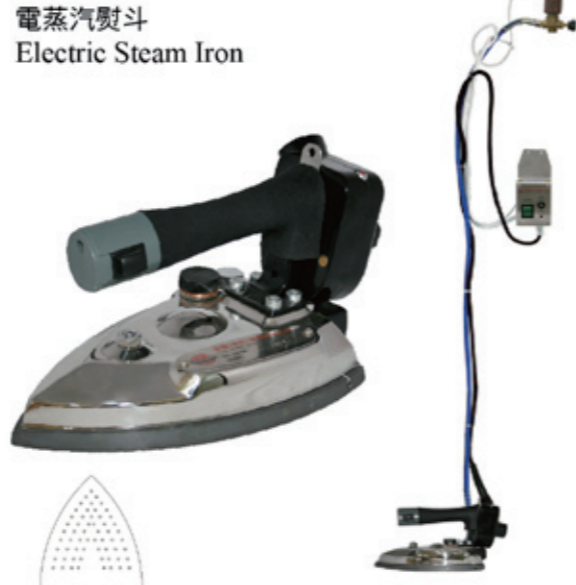

136 x 206mm

### NS-3602B

電蒸汽熨斗(帶汽水分离器)  
Electric Steam Iron(with steam trap)



116 x 202mm

### NS-3604

電蒸汽熨斗(同軸雙管原子喉)  
Electric Steam Iron(Double core Teflon Hose)

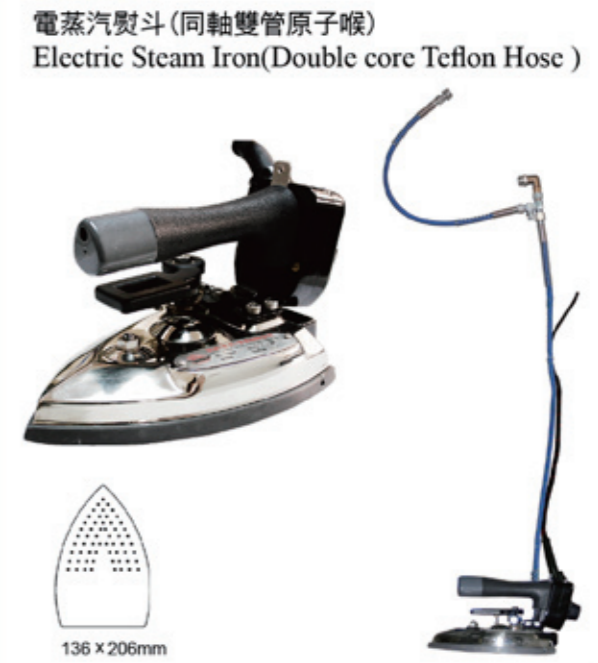

136 x 206mm

### NS-3601A

電蒸汽熨斗(帶汽水分离器)  
Electric Steam Iron(with steam trap)



136 x 206mm

### NS-3602A

電蒸汽熨斗  
Electric Steam Iron

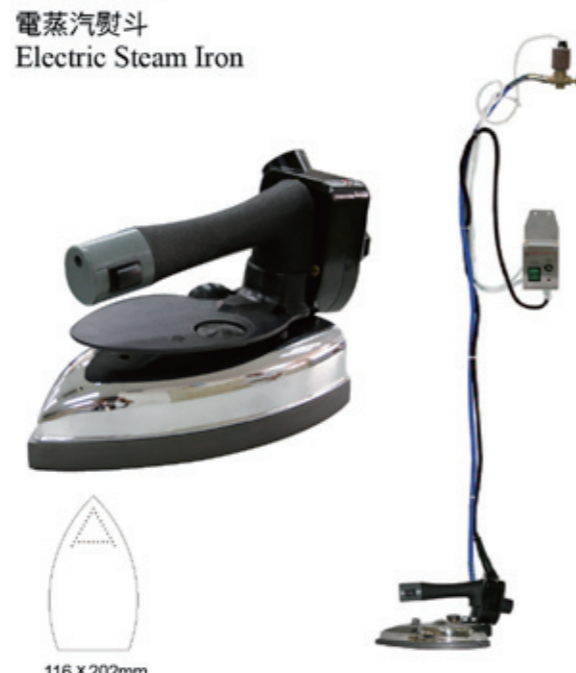

116 x 202mm

### NS-3700

全蒸汽熨斗  
Steam Heated Iron



140 x 200mm

### NS-3701

全蒸汽熨斗  
Steam Heated Iron



140 x 203mm

型號 Model	電源 Power Supply	總功率(kW) Total Power	最高設計溫度(°C) Max. Design Temp.	蒸汽壓力(kgf/cm <sup>2</sup> ) Steam Pressure	蒸汽開關 Steam Valve	淨重(kg) Net Weight	熨斗底尺寸(mm) Sole Size
NS-3600B	1PH/220V/50Hz	0.9	200	3~5	手撥式開關 Swing handle type switch	2.2	206x136
NS-3601					微動開關 Micro switch	2.6	206x136
NS-3601A					微動開關 Micro switch	2.6	206x136
NS-3602A					微動開關 Micro switch	2	202x116

型號 Model	電源 Power Supply	總功率(kW) Total Power	最高設計溫度(°C) Max. Design Temp.	蒸汽壓力(kgf/cm <sup>2</sup> ) Steam Pressure	蒸汽開關 Steam Valve	淨重(kg) Net Weight	熨斗底尺寸(mm) Sole Size
NS-3602B	1PH/220V/50Hz	0.9	200	3~5	微動開關 Micro switch	2	202x116
NS-3604					手撥式開關 Swing handle type switch	2.6	206x136
NS-3700	---	---	135		手撥式開關 Swing handle type switch	1.8	200x140
NS-3701					手撥式 Swing handle type	1.5	203x140



**NS-3702**  
全蒸汽熨斗  
Steam Heated Iron



100 x 205mm



**NS-3703**  
全蒸汽熨斗  
Steam Heated Iron

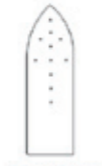

60 x 190mm



**NS-3704**  
全蒸汽熨斗  
Steam Heated Iron



140 x 200mm



**NS-3706**  
全蒸汽熨斗  
Steam Heated Iron



170 x 232mm



**NS-3800A**  
吊水斗  
Bottle Iron



120 x 210mm

型號 Model	最高溫度(°C) Max. Temp.	總功率(kW) Total Power	蒸汽壓力(kg/cm²) Steam Pressure	蒸汽開關 Steam Valve	淨重(kg) Net Weight	熨斗底尺寸(mm) Sole Size
NS-3702	135	---	3~5	手按式 Press handle type	1.3	205x100
NS-3703					1	190x60
NS-3704				2.6	200x140	
NS-3706						2.6
NS-3800A	200	1		微動開關 Micro switch	2.1	210x120

## 熨斗易損件及選購件 Wearing Parts & Optional Accessories of Irons

C28-010-02-1  
熨斗鞋 Teflon Shoe

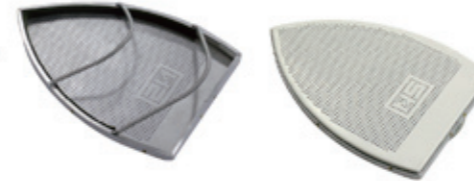

適用型號 Suitable for  
NS-3600A NS-3600B NS-3601 NS-3601A NS-3604

C28-010-01-1  
熨斗鞋 Teflon Shoe

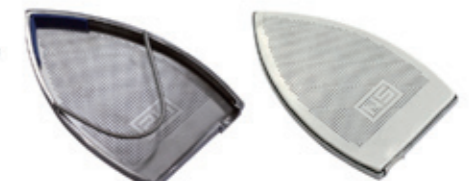

適用型號 Suitable for  
NS-3602B

C28-010-06-1  
熨斗鞋 Teflon Shoe



適用型號 Suitable for  
NS-3703

C28-010-03-1  
熨斗鞋 Teflon Shoe

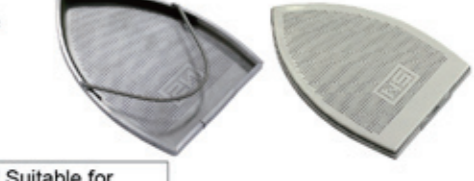

適用型號 Suitable for  
NS-3700 NS-3701 NS-3704

C28-010-05-1  
熨斗鞋 Teflon Shoe



適用型號 Suitable for  
NS-3702

C33-EA-HR-11  
發熱片 Heater



適用型號 Suitable for  
NS-3602B

C33-EA-HR-8  
燙斗底 Iron Sole



適用型號 Suitable for  
NS-3800A

C33-EA-HR-4  
發熱片 Heater



適用型號 Suitable for  
NS-3600A

C33-EA-HR-10  
發熱片 Heater



適用型號 Suitable for  
NS-3600B NS-3601 NS-3601A NS-3604

C33-EA-HR-12  
不銹鋼發熱片  
Stainless Steel Heater



C33-00082  
熨斗墊 Iron Pad



適用型號 Suitable for  
適用於藝誠所有熨斗  
Suitable for all the irons made by NgaiShing

C17-RP-004-1M  
3米原子線連接頭  
3M Teflon Hose with Fitting

適用型號 Suitable for  
NS-3600A NS-3600B NS-3602B  
NS-3601A NS-3701 NS-3702  
NS-3700 NS-3706  
NS-3703 NS-3601



C17-RP-004-4M G1/4"  
0.5米原子線連接頭  
0.5米 Teflon Hose with Fitting

適用型號 Suitable for  
NS-3602B NS-3604



C31-CES-10-33M  
吊熨斗彈簧 Iron Hanging Spring



APT15-00068  
布套 Cloth Sleeve



C33-00063  
吊杆 Hanging Rod



適用型號 Suitable for  
適用於藝誠所有熨斗 Suitable for all the irons made by NgaiShing





### 熨斗易損件及選購件

### Wearing Parts & Optional Accessories of Irons

C18-S-02-1E  
疏水閥 (1/4")  
Steam Trap (1/4")



適用型號 Suitable for
NS-3600A NS-3600B
NS-3601A NS-3602B
NS-3704 NS-3604

C33-EA-EV-1  
電磁閥  
Solenoid Valve



適用型號 Suitable for
NS-3800A

C33-3700-2  
排水閥  
Water Outlet Valve



適用型號 Suitable for
NS-3700 NS-3703 NS-3706

C33-3702-5  
排水閥  
Water Outlet Valve



適用型號 Suitable for
NS-3701 NS-3702

AC-E-01-2  
電源控制箱及電磁閥  
Electric Control Box with Solenoid Valve



適用型號 Suitable for
NS-3601 NS-3602A

AC-E-03-2  
氣水分離器連電磁閥、疏水閥  
Steam Water Separator with Solenoid Valve and Steam Trap



適用型號 Suitable for
NS-3601A NS-3602B

C02-EV-001-A02-7  
直導式電動控制閥  
Direct Actuating Electric Control Valve



適用型號 Suitable for
NS-3601A NS-3602B

CO1-TC-001-9  
溫度調節器 200°C  
Thermostat 200°C



適用型號 Suitable for
NS-3600A NS-3600B NS-3602B
NS-3601A NS-3800A
NS-3604 NS-3601

C33-EA-TC-7  
溫度保險  
Temperature Safety Fuse



適用型號 Suitable for
NS-3600B NS-3604
NS-3601A NS-3602B

C33-EA-SW-7  
微動開關  
Micro Switch



適用型號 Suitable for
NS-3601 NS-3602B NS-3601A NS-3800A

C33-00184-1  
雙管原子喉分水閥  
Steam Water Separator of Hose



適用型號 Suitable for
NS-3604 NS-3704

C33-3702-8  
蒸汽閥  
Steam Valve



適用型號 Suitable for
NS-3701 NS-3702 NS-3703

C33-3600-2-1  
蒸汽閥連閥芯  
Steam Valve with Core



適用型號 Suitable for
NS-3600A NS-3600B NS-3604

C33-3700-1-1  
蒸汽閥連閥芯  
Steam Valve with Core



適用型號 Suitable for
NS-3700 NS-3704 NS-3706

C33-00146  
蒸汽閥閥芯  
Core of Steam Valve



適用型號 Suitable for
NS-3600A NS-3600B NS-3604
NS-3700 NS-3704 NS-3706

氟橡膠圈  
Sealing Ring



適用型號 Suitable for
NS-3600A NS-3600B NS-3604

矽膠O型密封圈  
Sealing Ring



適用型號 Suitable for
NS-3700 NS-3704 NS-3706

矽膠O型密封圈  
Sealing Ring



適用型號 Suitable for
NS-3700 NS-3704 NS-3706

C33-3604-4  
手撥回位彈簧  
Swing Handle Return Spring



適用型號 Suitable for
NS-3600A NS-3600B NS-3604

C31-COS-06-1M  
手撥回位彈簧  
Swing Handle Return Spring



適用型號 Suitable for
NS-3700 NS-3704 NS-3706

### 熨斗供汽原理圖 Ironing Steam Supply Diagram

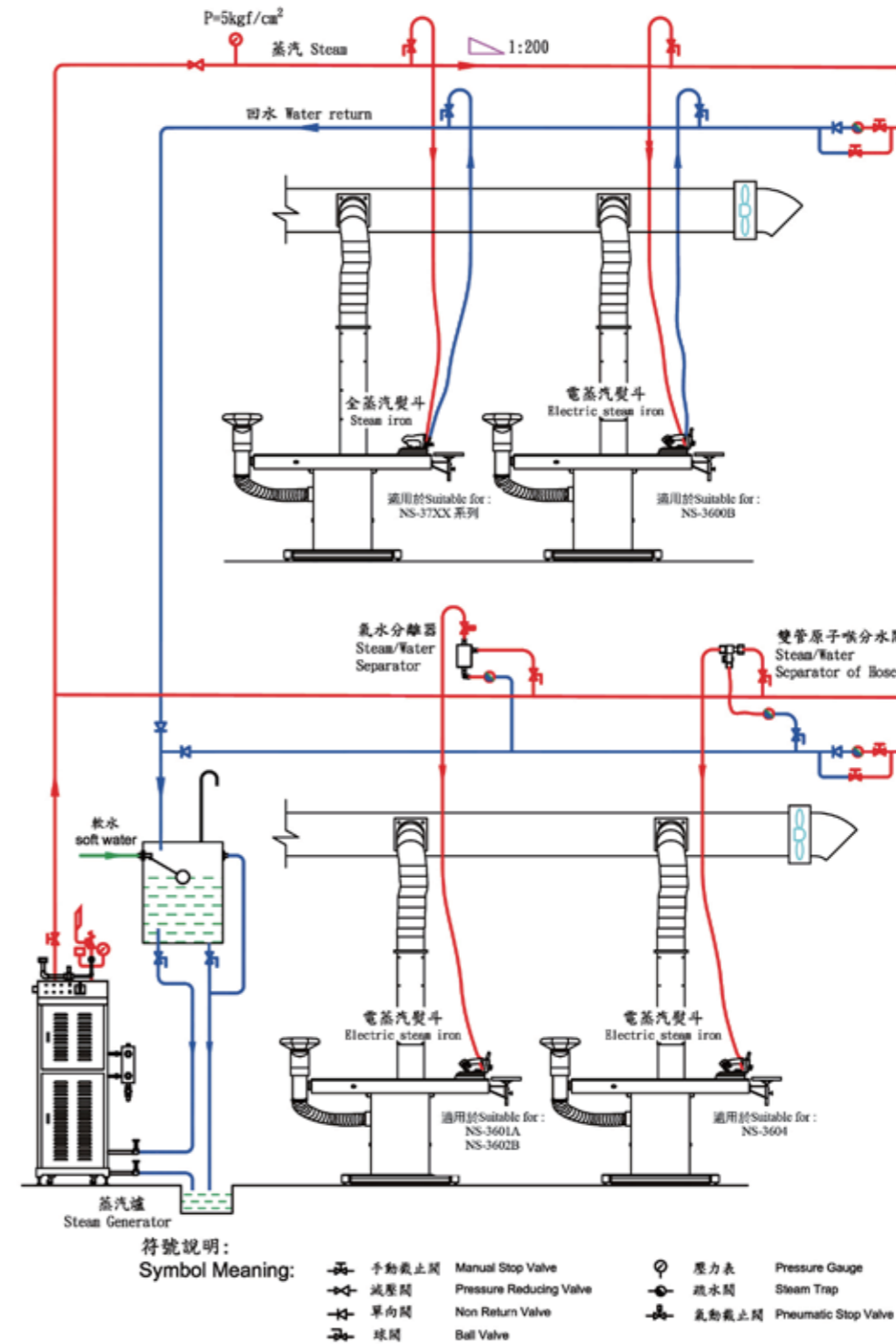

本公司可應客戶需要，為客戶設計設備平面佈置  
We could design equipment layout according to customers' requirement



**NS-3500**  
抽濕熨檯  
Vacuum Ironing Table



**NS-3502B**  
抽濕熨檯  
Vacuum Ironing Table



蒸汽鍋爐、熨斗、吊熨斗架、物料架、日光燈為選購件  
Options: Electric Steam Boiler, Iron, Iron Hanger, material stand, Fluorescent Lamp

**NS-3520**  
**NS-3521**  
**NS-3522**  
**NS-3523**  
單臂抽濕熨檯  
Vacuum Ironing Table  
with Single Buck



**NS-3541**  
**NS-3542**  
**NS-3543**  
**NS-3544**  
雙臂抽濕熨檯  
Vacuum Ironing Table  
with Double Buck



E

E



**NS-35XXB**

系列檯面可傾斜  
Tilttable table



雙層物料架(選購件)  
Double layer material stand(optional part)



熨檯大臂工作中  
Operation(big buck)

**NS-342**  
小型蒸汽鍋爐  
Electric Steam Boiler



型號 Model	電源 Power Supply	發熱線功率 (kW) Heater Power	馬達功率(kW) Motor Power	蒸汽壓力(kg/cm <sup>2</sup> ) Steam Pressure	蒸汽量(kg/hr) Steam Capacity	可選購熨鬥類型 Optional Irons could be Matched	檯面尺寸(inch) Table Size
NS-3500/NS-3500B	3PH/380V/50Hz	0.6	0.9	---	---	---	28x40
NS-3501/NS-3501B							28x48
NS-3502/NS-3502B							32x48
NS-3503/NS-3503B							32x54
NS-3504/NS-3504B							36x54
NS-3505/NS-3505B							36x60
NS-3506/NS-3506B							32x60
NS-3507/NS-3507B							36x48

型號 Model	電源 Power Supply	發熱線功率 (kW) Heater Power	馬達功率(kW) Motor Power	蒸汽壓力(kg/cm <sup>2</sup> ) Steam Pressure	蒸汽量(kg/hr) Steam Capacity	可選購熨鬥類型 Optional Irons could be Matched	檯面尺寸(inch) Table Size
NS-3520	3PH/380V/50Hz	0.8*	0.9	---	---	---	28x40
NS-3521							28x48
NS-3522							32x48
NS-3523							32x54
NS-3541							36x54
NS-3542							36x60
NS-3543							32x60
NS-3544	36x48						
NS-342-3.5-1	1PH/220V/50Hz	3.5*	0.37	3	5.25*	NS-3601 or(或) NS-3602A	---
NS-342-3.5-3	3.5						
NS-342-4.5-3	4.5*						
NS-342-5.5-3	5.5*						
					6.75*	NS-3700	
					8.25*	NS-3700	



### NS-3531

單臂女裝抽濕熨檯—右  
Vacuum Ironing Table with Single Buck-right



### NS-3534

單臂女裝抽濕熨檯—左  
Vacuum Ironing Table with Single Buck-left



### NS-3301A

清除衣物污垢檯  
Cleaning Table



### NS-3302A

清除衣物污垢檯  
Cleaning Table

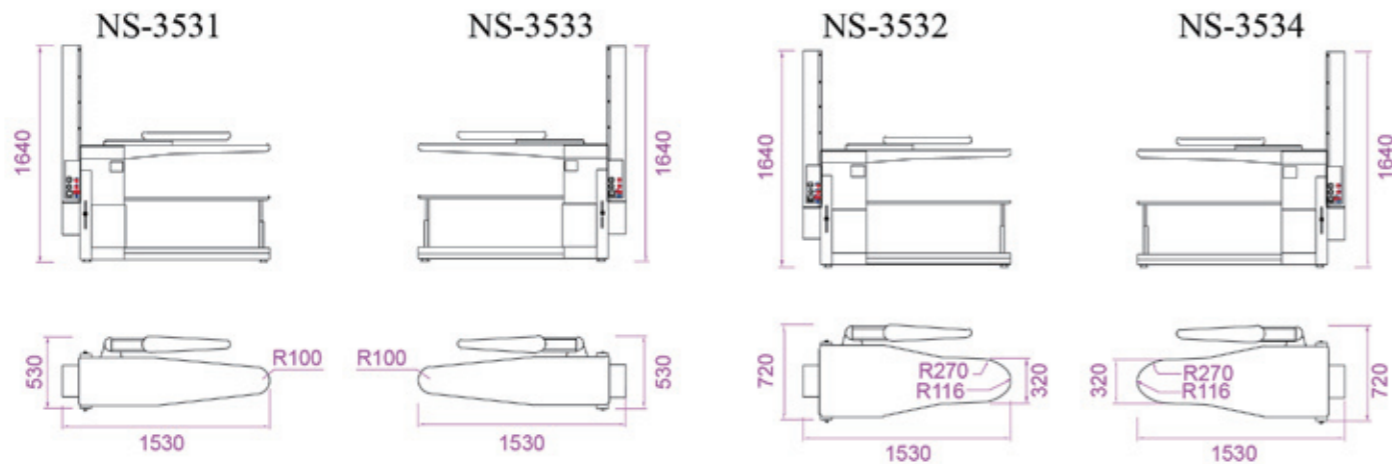

型號 Model	電源 Power supply	馬達功率 Motor Power (kW)	臺面發熱線功率 Table top heater (kW)	熨臂發熱線 Ironing Arm Heater(kW)	重量 Weight(kg)	機身尺寸 Machine Size(cm)
NS-3531	3PH/380V/50Hz	0.9	0.6	0.2	170	153x53x164
NS-3532					200	153x72x164
NS-3533					170	153x53x164
NS-3534					200	153x72x164

- NS-3301A C07-PT-006-01-1 特制藥水槍①一支，C07-PT-001-04-1 空氣噴槍②一支
- NS-3301A It is equipped with a special solvent gun ①, an air spray gun ②
- NS-3302A (需連接外部蒸汽供應設備) C07-PT-006-01-1 特制藥水槍③一支，C07-PT-001-04-1 空氣噴槍④一支，C07-PT-007-01-1 蒸汽噴槍⑤一支(蒸汽外置)
- NS-3302A (should be connected to the external steam supply unit) It is equipped with a special solvent gun ③, an air spray gun ④ and a team spray gun ⑤(external steam supply)



選購件：電動噴藥槍C08-011-1  
Option: Electric solvent gun

型號 Model	電源 Power supply	總功率(kW) Total Power	耗壓縮空氣量(L/min) Compressed Air Consumption	蒸汽壓力(kgf/cm <sup>2</sup> ) Steam Pressure	耗蒸汽量(kg/hr) Steam Consumption	機身尺寸(cm) Machine Size
NS-3301A	1PH/220V/50Hz	0.85	20	---	---	139x50x182
NS-3302A				3~5	10	



### 熨檯配件 FITTINGS OF IRONING TABLE

吊熨斗架  
Iron Hanger



吊熨斗架E  
Iron Hanger  
O-E-01-5

單層物料架(上)  
Single-layer material  
stand(upper)  
O-E-04-2

單層物料架(下)  
Single-layer material  
stand(lower)  
O-E-04-3

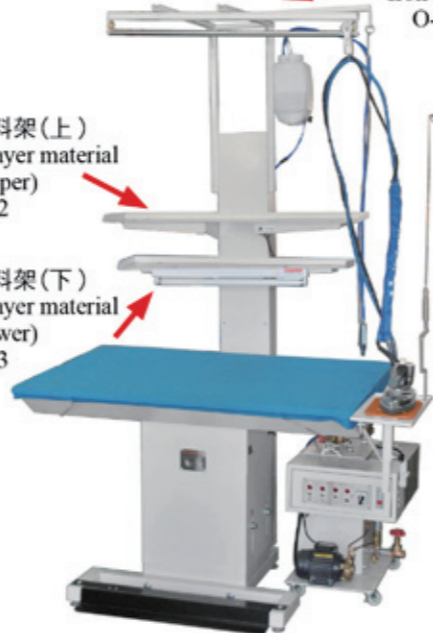

附設熨架，最適用於掛裝及時裝  
Ironing buck, good for hanger  
pack garment



1.耐熱熨布 2.泡棉熨毯 3.鋼絲網  
1.Heat resistant fabric 2.Ironing  
pad 3.Steel wire mesh



拉布彈簧、勾仔  
Fabric spread spring, hook

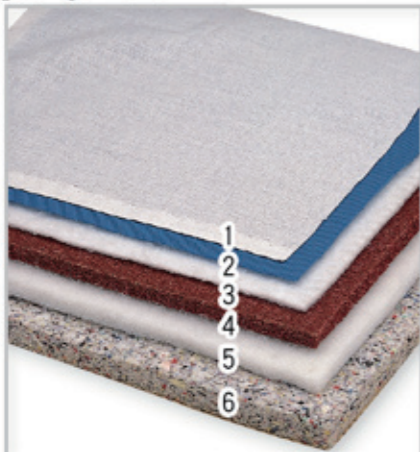

各種熨褥  
Various Type of Ironing Pad

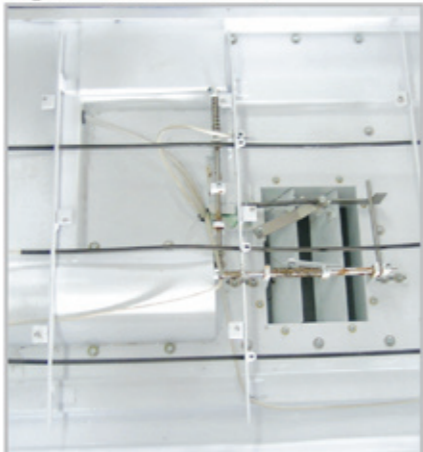

發熱線及強力抽風門  
Heater and Powerful Vacuum Door



機身高度可調  
Adjustable Height

### 熨台 熨架選擇 Ironing Table Buck Option:

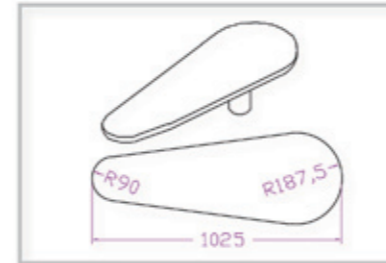

UF  
萬能熨架  
Universal Front Buck

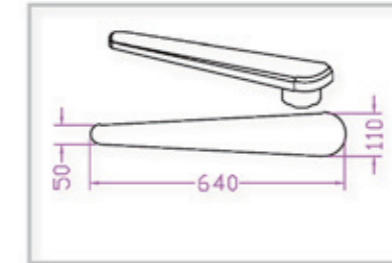

US  
萬能袖架  
Universal Sleeve Buck

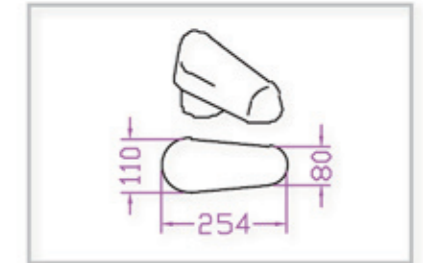

SBM  
男裝肩膀熨架  
Shoulder Buck for Men

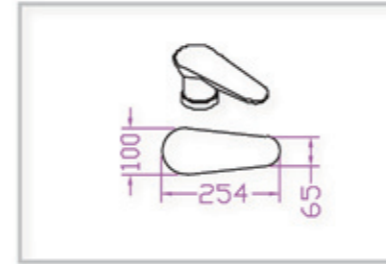

AH  
袖山熨架  
Arm Hole Buck

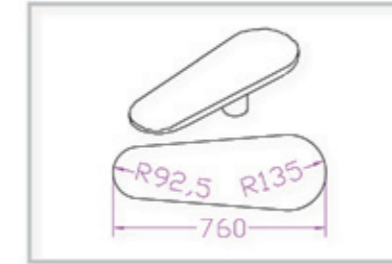

JF  
機恤熨架  
Jacket Front Buck

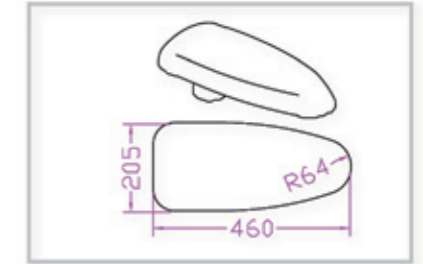

T-A  
褲頭熨架  
Trousers Topper Buck A

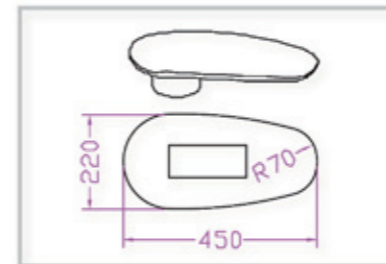

T  
褲頭熨架  
Trousers Topper Buck

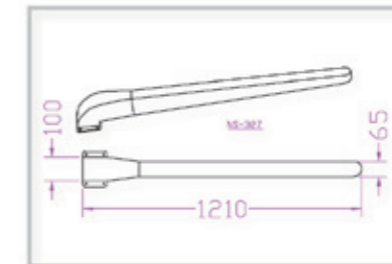

TS  
褲骨熨架  
Trousers Seam Buck

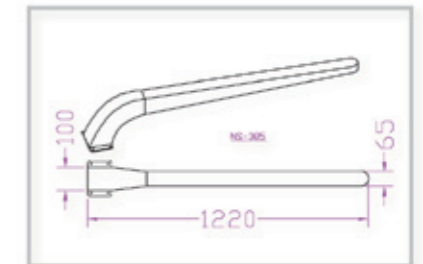

TS-A  
褲骨熨架 A  
Trousers Seam Buck A



### NS-55

吸線頭機連電眼感應  
Thread Cleaning Machine with Electric Eye Sensor



### NS-54

吸線頭機  
Thread Cleaning Machine



### NS-3110

剪線頭機  
Thread Trimming Machine

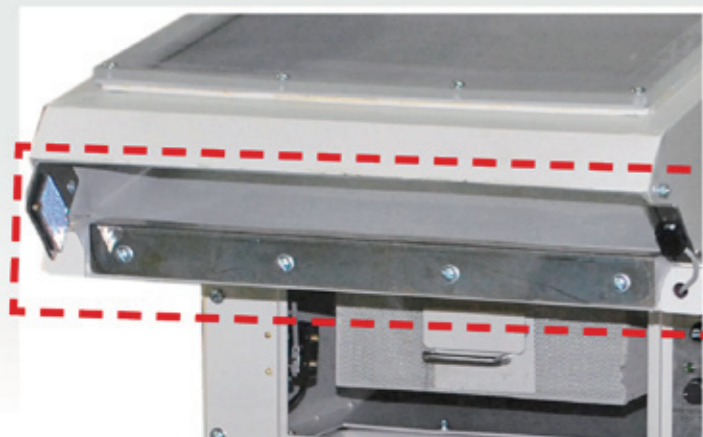

NS-55電眼感應  
Electric eye sensors



NS-55工作中  
In Working



NS-54線頭過濾箱  
Thread collecting basket



NS-3110自動剪線及吸線頭  
Thread trimming and sucking

型號 Model	電源 Power Supply	馬達功率(kW) Motor Power	吸線區尺寸LxW(cm) Sucking area	淨重(kg) Net Weight	毛重(kg) Gross Weight	機身尺寸(cm) Machine Size
NS-55	3PH/380V/50Hz	3	120x56	255	315	75x125x141

型號 Model	電源 Power Supply	馬達功率(kW) Motor Power	吸線區尺寸LxW(cm) Sucking area	淨重(kg) Net Weight	毛重(kg) Gross Weight	機身尺寸(cm) Machine Size
NS-54	3PH/380V/50Hz	3	120x56	250	310	66x124x144
NS-3110	1PH/220V/50Hz	0.65	--	46	71*	107x57x116



### NS-355A

噴蒸汽抽濕熨檯  
Steam Spray Vacuuming  
Ironing Table



E

### NS-8513

人像機  
Body Press



### NS-8514

人像機連自動夾  
Body Press with Automatic Clip



E



熨板(跟機件)  
Ironing board(Standard)



放衣架 O-E-02-3(跟機件)  
Garment stand(Standard)



毛衣無袖衣架 O-E-02-1(選購件)  
Sweater frame without sleeve(OPTION)

毛衣有袖衣架 O-E-02-2(選購件)  
Sweater frame with sleeve(OPTION)

NS-355A工作中  
In working

型號 Model	電源 Power supply	蒸汽壓力 (kgf/cm <sup>2</sup> ) Steam Pressure	耗蒸汽量(kg/hr) Steam Consumption	壓縮空氣壓力 (kgf/cm <sup>2</sup> ) Compressed Air Pressure	耗壓縮空氣量 (L/min) Compressed Air Consumption	檯面尺寸 (mm) Table Size	機身尺寸 (cm) Machine Size
NS-355A	3PH/380V/50Hz	3~5	60~100	5	1.5	980x1800	200x103x110



NS-8513 選購件：袖架  
Option: Sleeve frame

NS-8513 選購件 optional：  
O-E-03-1 袖形架 sleeve frame

NS-8514 自動夾  
Automatic clip

型號 Model	電源 Power supply	耗電量(kW) Power Consumption	耗蒸氣量(kg/hr) Steam Consumption	機身尺寸(cm) Machine Size
NS-8513	3PH/380V/50Hz	0.75	30	125x56x165
NS-8514			35	150x60x150*



### 運輸帶系統 Conveyor System



NS-200A 特殊防塵設計，輸送鏈條上的油污不會滴落到衣服上，保持衣物清潔  
Special dust proof structure to prevent oil from dropping to the garment from the chain and keep the garment clean

型號 Model	電源 Power supply	運輸帶長度(英尺) Belt Conveyor Length(feet)	馬達功率 Motor Power(HP)	變頻器功率 Frequency Converter Power(HP)	標準長度每段(英尺) Standard Length of Each Section(feet)	標準帶寬(吋) Standard Conveyor Width(inch)
NS-200A/NS-300	3PH/380V/50Hz	32~96	1.5	2	8	18 · 24



型號 Model	電源 Power supply	運輸帶長度(英尺) Belt Conveyor Length(feet)	馬達功率 Motor Power(HP)	變頻器功率 Frequency Converter Power(HP)	標準長度每段(英尺) Standard Length of Each Section(feet)
NS-400	3PH/380V/50Hz	32~96	1.5	2	8



### NS-650U

氣動折衫台連物料架和放針架  
Pneumatic Shirt Folding Table  
With Material & Pin Stand



### NS-651

氣動摺衫檯  
Pneumatic Shirt Folding Table



F

F

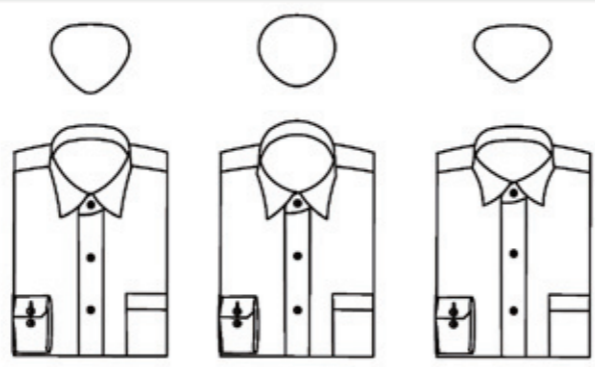

- NS-650U:**
- 尺寸可伸縮調節;
  - 可根據需要選購不同形狀領模(三角形, 圓形, 杏圓形)
  - 傾斜臺面, 操作方便。
- NS-650U:**
- The size is expandable
  - Users can purchase different shaped collar mould(triangular, round, pear);
  - Slant table for easy operation

杏圓形領模 Pear collar      圓形領模 Round collar      三角形領模 Triangular collar

每款模都有大(18"~23"),中(14½"~18"),小碼(12"~14½")三種  
Each type of mould has large(18"~23"),middle(14½"~18") and small(12"~14½") size.

型號 Model	電源 Power Supply	總功率(kW) Total Power	壓縮空氣壓力(kgf/cm <sup>2</sup> ) Compressed Air Pressure	檯面高度(mm) Table height	淨重(kg) Net Weight	機身尺寸(cm) Machine Size
NS-650U	1PH/220V/50Hz	0.3	5	680~910	88	135x80x120

NS-650U/NS-651選購件  
Optional Part of NS-650U/NS-651:

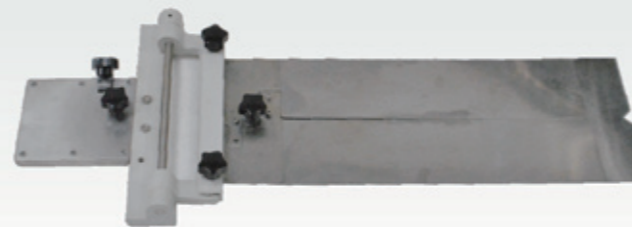

A632 活動摺衫板  
Adjustable shirt folding plate

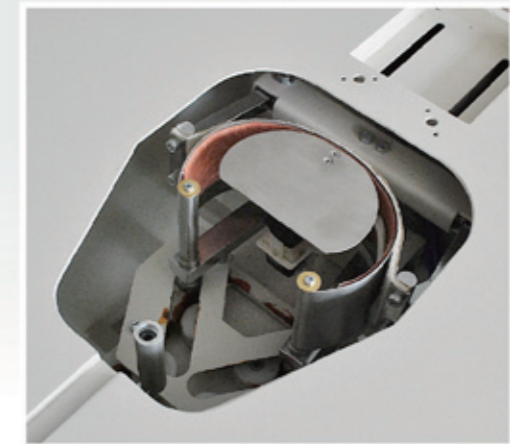

NS-651領模  
Collar Mould

型號 Model	電源 Power supply	總功率(kW) Total Power	圍領寬度(mm) Collar Folding Width	圍領範圍(inch) Collar Folding Size	壓縮空氣壓力(kgf/cm <sup>2</sup> ) Compressed Air Pressure	檯面高度(inch) Table height	最高設計溫度(°C) Max. Design Temp	機身尺寸(cm) Machine Size
NS-651	1PH/220V/50Hz	0.2	115~150	14½"~18"	5	30"~34"	120	125x81x145





# 男女襯衫專用整熨設備

## Man & Lady Shirt Pressing Equipment

### NS-50-S

摺衫台  
Shirt Folding Table



### NS-650U-S

氣動摺衫台  
Pneumatic Shirt Folding Table



### NS-50

摺衫檯  
Shirt Folding Table

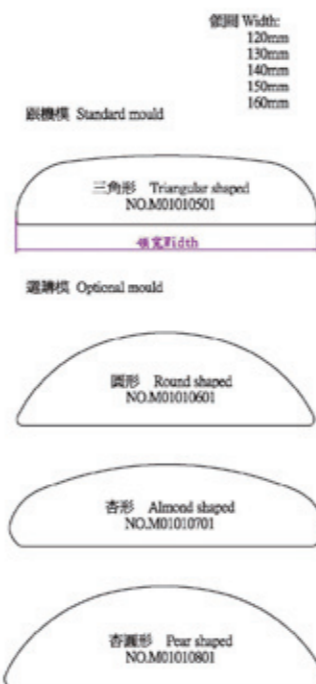

F

F



NS-50-S配合熨台(選購件)安裝效果相  
Installation appearance of the folding table  
NS-50-S and an ironing table(option)



NS-50-S工作中  
In working

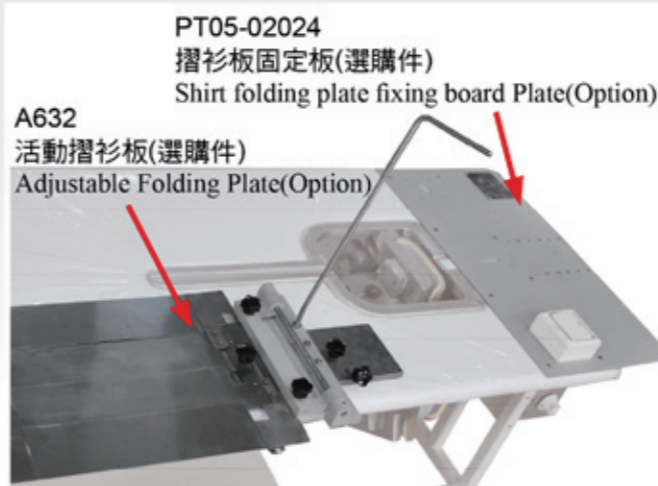

以上兩款需配合使用  
The above two types should work with each other

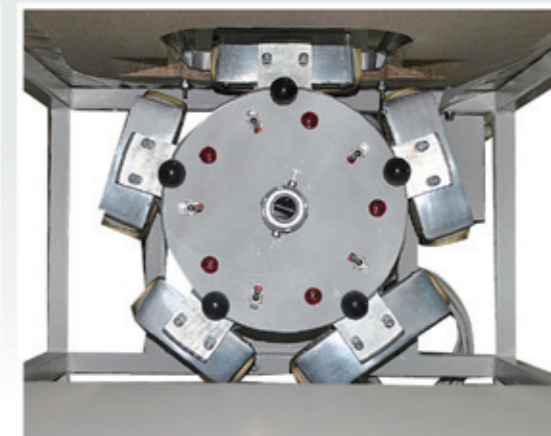

NS-50 可轉動機頭，備有5個不同尺寸模  
Rotary head equipped with 5 different sized  
pressing mould

型號 Model	電源 Power supply	發熱線功率(kW) Heater Power	壓縮空氣壓力 (kgf/cm <sup>2</sup> ) Compressed Air Pressure	耗壓縮空氣量 (L/min) Compressed Air Consumption	檯面尺寸 LxW(mm) Table Size	機身可調高度(mm) Adjustable Table Height	機身尺寸(cm) Machine Size
NS-50-S	1PH/220V/50Hz	0.5	5	5*	650x800*	830~930*	65x80x83*
NS-650U-S		0.3*				760~830*	65x80x83*
NS-651-S		0.2*		2*	700x800*	70x80x83*	

型號 Model	電源 Power supply	總功率(kW) Total Power	壓縮空氣壓力(kgf/cm <sup>2</sup> ) Compressed Air Pressure	檯面高度(mm) Table height	淨重(kg) Net Weight	機身尺寸(cm) Machine Size
NS-50	1PH/220V/50Hz	0.5	5	835	62	123x77x135



# 男女襯衫專用整熨設備

## Man & Lady Shirt Pressing Equipment

### NS-8143M

電加熱式男裝領袖壓平機  
Electric Heated Man Shirt Collar  
and Cuff Press



### NS-8443M

自動電加熱式領袖壓平機  
Automatic Electric Heated  
Collar and Cuff Press



### NS-8242P

自動袖口壓平機  
Automatic Cuff Press



### NS-8245P

自動平面壓平機  
Automatic Flat Press



### NS-8243MP-L

自動領袖壓平機 (男裝)  
Automatic Collar and Cuff  
Press (Man)



NS-8243MP-L 操作效果  
Pressing effect

### NS-8410P

垂直式壓領機  
Vertical Collar Press Machine



NS-8410P 特別設計模，配合不同恤衫領面  
Special designed mould for fitting for various kinds  
of shirt collar shape

型號 Model	電源 Power supply	總功率(kW) Total Power	壓縮空氣壓力(kgf/cm <sup>2</sup> ) Compressed Air Pressure	耗壓縮空氣量(L/min) Compressed Air Consumption	下模尺寸(mm) Lower mould Size	機身尺寸(cm) Machine Size
NS-8143F	3PH/380V/50Hz	5	5	150	領：535x150x105	156x156x200
NS 8143M					袖：150x150x130	
NS-8243F					領：535x150x105	142x127x152
NS-8243FP-L					袖：150x150x130	
NS-8243M					領：535x260x105	133x85x215
NS-8243MP-L					袖：150x260x130	
NS-8443F					領：535x150x105	133x85x215
NS-8443M					袖：205x150x130	

型號 Model	電源 Power supply	總功率(kW) Total Power	壓縮空氣壓力(kgf/cm <sup>2</sup> ) Compressed Air Pressure	耗壓縮空氣量(L/min) Compressed Air Consumption	淨重(kg) Net Weight	機身尺寸(cm) Machine Size
NS-8242P	3PH/380V/50Hz	2.5	5	100	420	99x123x155
NS-8245P		6.3				140x125x170
NS-8410P		4.7				134x106x209



# 男女襯衫專用整熨設備

Man & Lady Shirt Pressing Equipment

NS-8249

冷熱圈領機  
Hot and Cool Head Collar  
Creasing Machine



F

NS-8249-D

雙頭冷熱圈領機  
Double Hot and Cool Head Collar  
Creasing Machine



NS-8247

圈領機(單頭)  
Collar Creasing Press-Single



NS-8248W

雙頭冷熱圈領機 — 水冷  
Hot and Cool Head Collar Creasing  
Press(Water Cooling)



F



NS-8249-D 雙側同時操作  
Creasing of both sides(simultaneously)

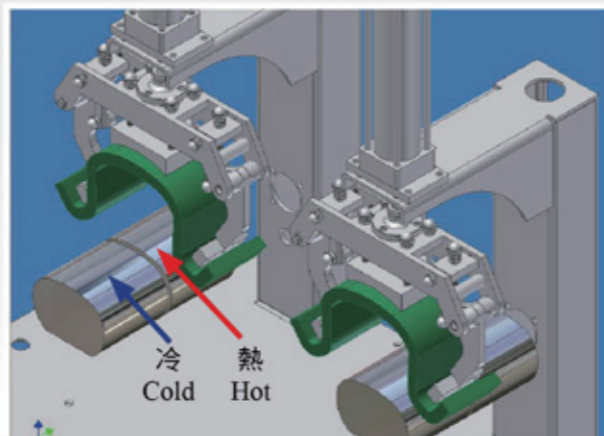

a. 熱壓狀態 Hot creasing status  
b. 冷壓狀態 Cold creasing status



圈領效果  
Collar creasing result



NS-8248W 備獨立冷卻系統  
With built-in cooling system

型號 Model	電源 Power supply	發熱線(kW) Heater	冷凍機(HP) Cooling Machine	壓縮空氣壓力(kg/cm <sup>2</sup> ) Compressed Air Pressure	耗壓縮空氣量 (L/min) Compressed Air Consumption	機身尺寸(cm) Machine Size
NS-8249	1PH/220V/50Hz	1	0.25	5	80	72x84x170
NS-8249-D		2			100	98x80x170

型號 Model	電源 Power supply	發熱線(kW) Heater	冷凍機(HP) Cooling Machine	淨重(kg) Net Weight	機身尺寸(cm) Machine Size
NS-8247	1PH/220V/50Hz	1	---	63	71x45x170
NS-8248W			0.25	160	94x56x170



### NS-45

電動釘鈕機  
Electric Snap Fixing Machine



NS-45 釘鈕操作  
Snap fixing

### NS-47U

氣動釘鈕機-連十字定位燈及安全罩  
Pneumatic Snap Fixing Machine with  
Light Marker & Safety Guard



NS-47U 安全防護罩  
在工作中，安全環下移到位后沖頭  
才能開始釘鈕動作；若中途有任何  
障礙物碰到安全環，安全裝置都會  
阻止沖頭下移，提高操作安全

During working, the punching  
head could start punching only  
when the safety ring reaches a  
fixed position, if the ring touches  
any object, it will act and prevent  
the punching head from moving  
down, in this way the operation  
safety is ensured

### NS-9085-D-N

牛仔褲折袋機  
Jeans Pocket Creasing Machine

### NS-9085-D-L

牛仔褲折袋機 - 加大  
Jeans Pocket Creasing Machine - Large



適用於牛仔布袋的焗熨，  
可將斜邊袋口的突出部分反摺  
This machine is suitable for jeans pocket blocking,  
especially it has the function of turning and folding  
the pocket edge corner for avoiding it extending out

### NS-6032

自動裝袋機  
Automatic Pocket Setter



效果圖 Finished result

型號 Model	電源 Power Supply	總功率(kW) Total Power	耗壓縮空氣量 (L/min) Compressed Air Consumption	最大沖程(mm) Max. Stroke	淨重(kg) Net Weight	機身尺寸(cm) Machine Size
NS-45	1PH/220V/50Hz	0.2	---	50	45	84x53x124
NS-47U			30		62	62x41x132
NS-47					59	

型號 Model	電源 Power supply	總功率(kW) Total Power	壓縮空氣壓力(kgf/cm <sup>2</sup> ) Compressed Air Pressure	耗壓縮空氣量(L/min) Compressed Air Consumption	最大摺袋尺寸 Max. Size of Creased Pocket(mm)	機身尺寸(cm) Machine Size
NS-6032	1PH/220V/50Hz	1	5	20	---	170x137x170
NS-9085-D-N		2.2		50	190x190	84x97x147
NS-9085-D-L					250x250	



### NS-716

自動西褲褲頭車架連6位細條送料架  
Auto Classic Waist Band Sewing Stand with 6 Strip Feeding Frame



NS-716工作中  
In Working



### NS-715

捲褲頭機  
Waist Band Winding Machine



### NS-717-1

自動鬆細條架  
Auto Ribbon Loosening Stand



### NS-5601

褲頭粘合機  
Waistband Fusing Machine



NS-5601 粘褲襠  
Waistband and tape fusing

### NS-5650

耳仔轉熨機  
Belt Rotary Pressing Machine



### NS-6040

切耳仔器  
Belt Loop Cutting Device



型號 Model	電源 Power supply	總功率(kW) Total Power	壓縮空氣壓力(kg/cm <sup>2</sup> ) Compressed Air Pressure	耗壓縮空氣量(L/min) Compressed Air Consumption	機身尺寸(cm) Machine Size
NS-715	1PH/220V/50Hz	0.2	---	---	61x50x129
NS-716		0.04	5	5	52x64x130
NS-717	---	--	--	--	84x53x124
NS-717-1	1PH/220V/50Hz	0.3	--	--	52x54x165

型號 Model	電源 Power supply	總功率(kW) Total Power	粘合壓力(kg/cm <sup>2</sup> ) Fusing Pressure	耗壓縮空氣量(L/min) Compressed Air Consumption	最高設計溫度 Max Design Temp. (°C)	最大粘合寬度(inch) Max. Fusing Width	耳仔寬度(inch) Belt Loop Width	機身尺寸(cm) Machine Size
NS-5601	1PH/220V/50Hz	4.6	0.5	--	200	1½~4	--	223x87x50
NS-5650		1.74	--	--		--	5/16~3/4	100x45x33
NS-6040		0.1	--	10	--	--	--	15x23x29



### NS-710

反褲機  
Reversing Trousers Machine



NS-710 工作中  
In working



### NS-720

反褲袋機  
Trousers Pocket Reversing Machine



NS-720 工作中  
In working



### NS-385

熨褲骨機  
Trousers Seam Ironing Table



NS-385 工作中  
In Working



### NS-385D

熨褲骨機 — 雙臂  
Trousers Seam Ironing Table – Double Buck



### NS-333

褲頭熨檯  
Trousers Topper Ironing Table



型號 Model	電源 Power supply	總功率(kW) Total Power	壓縮空氣壓力(kgf/cm <sup>2</sup> ) Compressed Air Pressure	耗壓縮空氣量(L/min) Compressed Air Consumption	機身尺寸(cm) Machine Size
NS-710	3PH/380V/50Hz	3.2	5	60	183x84x130
NS-720		1.2		10	107x84x113

型號 Model	電源 Power Supply	馬達(kW) Motor	熨臂檯面發熱線(kW) Heater of Ironing Arm	淨重(kg) Net Wt.	機身尺寸(cm) Machine Size
NS-333	3PH/380V/50Hz	0.9	0.2	130	103x76x104
NS-385			0.3	105	181x75x170
NS-385D			0.6	115	180x70x170



### NS-8118D-E

自動雙褲管壓平機  
Automatic Double Legger Press

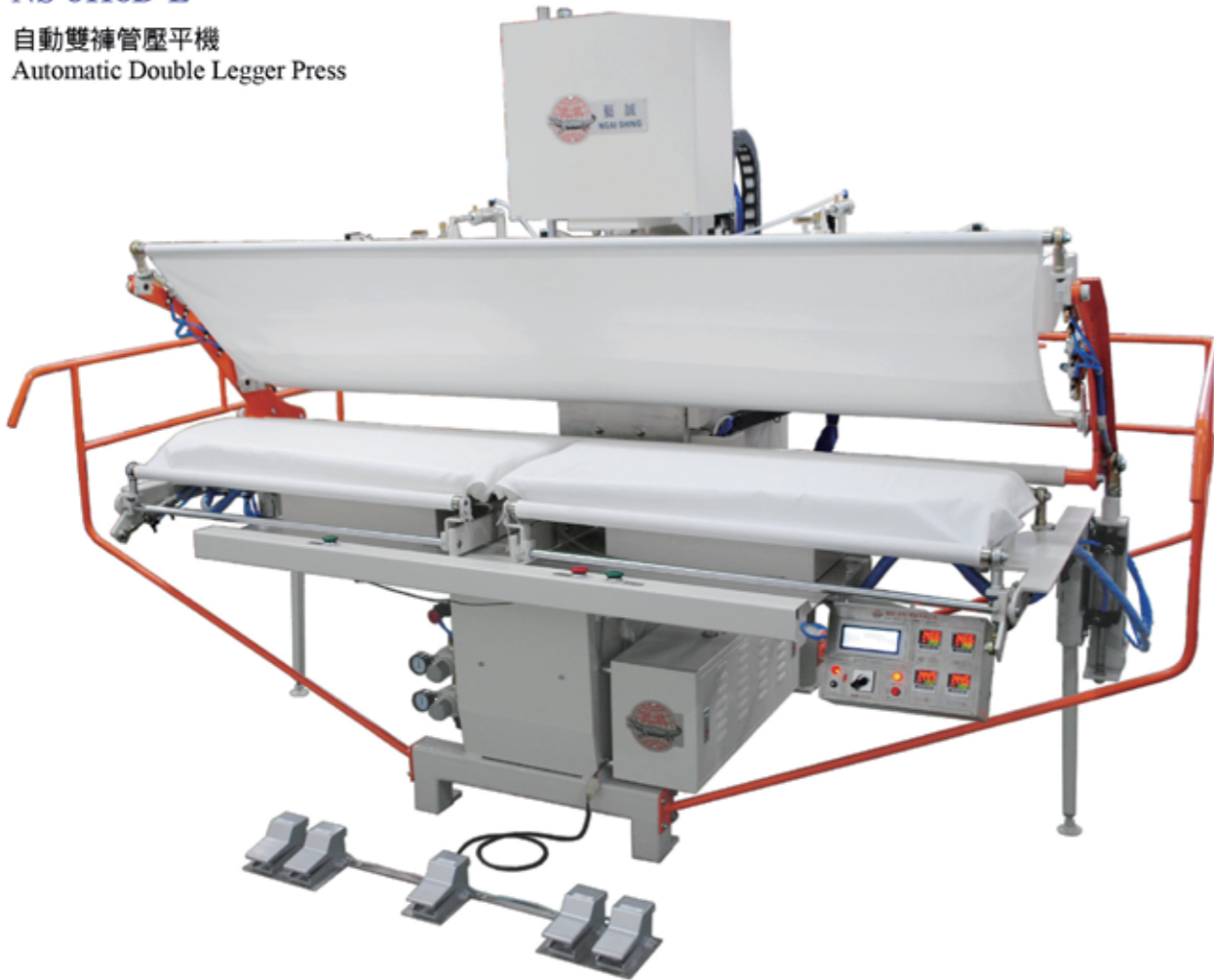

特製壓布框，可自動拉展褲管  
Special fabric clamping frame could stretch and hold trousers' legs automatically so as to get a better pressing effect



操作圖  
In working

型號 Model	電源 Power supply	總功率(kW) Total Power	耗蒸汽氣量(kg/hr) Steam Consumption	壓縮空氣壓力(kgf/cm <sup>2</sup> ) Compressed Air Pressure	耗壓縮空氣量(L/min) Compressed Air Consumption	機身尺寸(cm) Machine Size
NS-8118D-E	3PH/380V/50Hz	9.2	25*	5	200	296x180x210

### NS-8218AV

自動褲管壓平機(蒸汽加熱)  
Automatic Legger Press(Steam heating)

### NS-8318AV

自動電加熱式褲管壓平機(蒸汽+電加熱)  
Automatic Electric Heated Legger Press  
(Steam & Electric Heating)



NS-8318AV/NS-8319AV  
控制面板  
Control panel

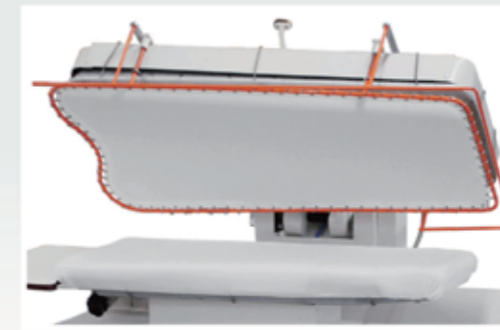

NS-8218AV/NS-8318AV  
特設熨布架  
Special fabric pre-holding frame

### NS-8219AV

自動褲頭壓平機(蒸汽加熱)  
Automatic Topper Press(Steam heating)

### NS-8319AV

自動電加熱式褲頭壓平機(蒸汽+電加熱)  
Automatic Electric Heated Topper Press  
(Steam & Electric Heating)



NS-8219AV/NS-8319AV  
特設熨布架  
Special fabric pre-holding frame

型號 Model	電源 Power Supply	總功率(kW) Total Power	壓縮空氣壓力(kgf/cm <sup>2</sup> ) Compressed Air Pressure	耗壓縮空氣量(L/min) Compressed Air Consumption	耗蒸汽氣量(kg/hr) Steam Consumption	淨重(kg) Net Weight	機身尺寸(cm) Machine Size
NS-8218AV	1PH/220V/50Hz	0.2	5	150	30	510	160x105x168
NS-8318AV	3PH/380V/50Hz	4.7			20	552	
NS-8219AV	1PH/220V/50Hz	0.2		100	15	352	92x110x170
NS-8319AV	3PH/380V/50Hz	2.6			12	348	



### NS-8219 NS-8219P

自動褲頭壓平機(蒸汽加熱)  
Automatic Topper Press(Steam Heating)



### NS-8319 NS-8319P

自動電加熱式褲頭壓平機(蒸汽+電加熱)  
Automatic Electric Heated Topper Press  
(Steam & Electric Heating)



### NS-8218 NS-8218P

自動褲管壓平機(蒸汽加熱)  
Automatic Legger Press(Steam Heating)



### NS-8318 NS-8318P

自動電加熱式褲管壓平機(蒸汽+電加熱)  
Automatic Electric Heated Legger Press  
(Steam & Electric Heating)



工作中  
In working



NS-8219P  
控制面板Control panel



NS-8219  
控制面板Control panel

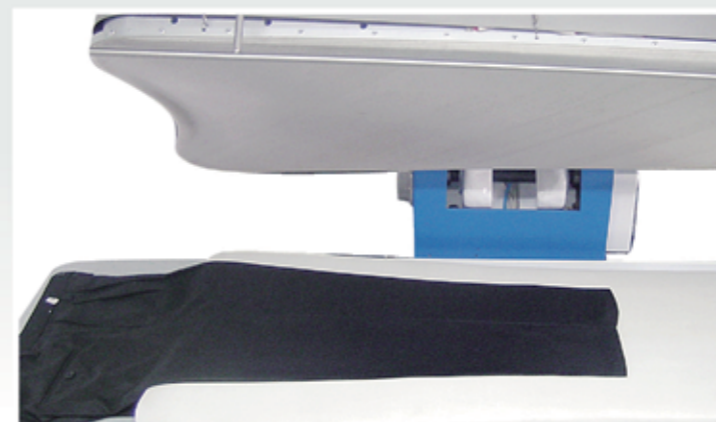

工作中  
In working



NS-8318P  
控制面板 Control panel



NS-8318  
控制面板 Control panel

型號 Model	電源 Power supply	總功率(kW) Total Power	耗蒸汽氣量(kg/hr) Steam Consumption	耗壓縮空氣量(L/min) Compressed Air Consumption	壓縮空氣壓力(kgf/cm <sup>2</sup> ) Compressed Air Pressure	淨重(kg) Net. Weight	機身尺寸(cm) Machine Size
NS-8219	1PH/220V/50Hz	0.1	15	100	5	342	92x105x167
NS-8219P						345	
NS-8319	3PH/380V/50Hz	2.5	12			338	92x105x167
NS-8319P						340	

型號 Model	電源 Power supply	總功率(kW) Total Power	耗蒸汽氣量(kg/hr) Steam Consumption	耗壓縮空氣量(L/min) Compressed Air Consumption	壓縮空氣壓力(kgf/cm <sup>2</sup> ) Compressed Air Pressure	淨重(kg) Net. Weight	機身尺寸(cm) Machine Size
NS-8218	1PH/220V/50Hz	0.1	30	150	5	500	160x107x165
NS-8218P						502	
NS-8318	3PH/380V/50Hz	4.6	20			504	
NS-8318P						504	





NS-8510  
褲像整熨機  
Trousers Finisher



- 適用於吹熨牛仔褲、燈芯絨褲、斜紋褲管休閒類褲
- 備加熱器，提高蒸汽質量
- 可吹熨長褲和短褲
- 操作簡單，維修容易
- 備褲長控制功能：
  - 預定褲長
  - 長拉
  - 原褲長
  - 原褲長拉直（脈沖動作）
- Suitable for blowing and ironing jeans, corduroy and twill trousers
- Equipped with heat exchanger, could improve steam quality
- Could blow and iron any long trousers and shorts
- Easy to operate, convenient to maintain
- Trousers length control includes:
  - preset length stop
  - continuous stretch
  - reach length stop
  - reach length stop(pulse action)

型號 Model	電源 Power Supply	總功率(kW) Total Power	壓縮空氣壓力(kgf/cm <sup>2</sup> ) Compressed Air Pressure	耗壓縮空氣(L/min) Compressed Air Consumption	蒸汽壓力(kgf/cm <sup>2</sup> ) Steam Pressure	耗蒸汽量(kg/hr) Steam Consumption	機身尺寸(cm) Machine Size
NS-8510	3PH/380V/50Hz	3.8	5	26	3~5	20	80x150x201

NS-8510L  
工作服整熨機  
Work Overall Finisher



NS-8510U  
褲像整熨機連褲頭熨架  
Trousers Finisher with Topper Press



NS-8510L  
工作中  
In working



NS-8510U  
工作中  
In working

型號 Model	電源 Power Supply	總功率(kW) Total Power	壓縮空氣壓力(kgf/cm <sup>2</sup> ) Compressed Air Pressure	耗壓縮空氣量(L/min) Compressed Air Consumption	蒸汽壓力(kgf/cm <sup>2</sup> ) Steam Pressure	耗蒸汽量(kg/hr) Steam Consumption	機身尺寸(cm) Machine Size
NS-8510U	3PH/380V/50Hz	3.8	5	26	3~5	25	168x156x201
NS-8510L				25			180x170x251



### 褲整熨及輔助設備下模尺寸簡圖

### Lower Mould Dimensions of Trousers Ironing & Assisting Equipment

NS-8219, NS-8319, NS-8219P, NS-8319P, NS-8219AV & NS-8319AV,

A款B款為客戶特殊定貨用。C款為標準型。D款為加大型。四款下模的尺寸提供參考。

Model A and B are specially made to order for customer, C is standard and D is enlarged model.

Size of four lower moulds is below:



A款尺寸簡圖  
Size of model A

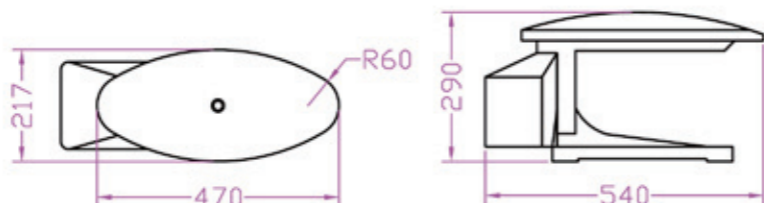

B款尺寸簡圖  
Size of model B

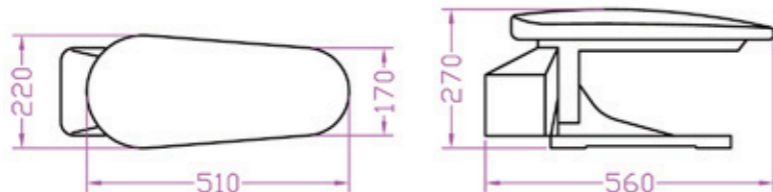

C款尺寸簡圖(標準型)  
Size of model C(Standard model)

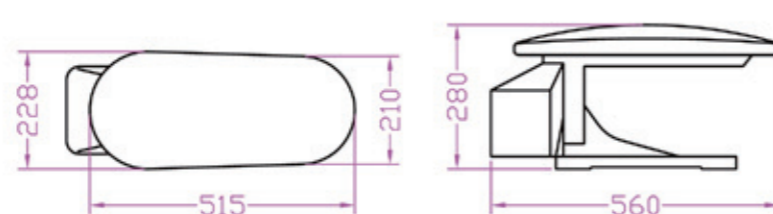

D款尺寸簡圖  
Size of model D

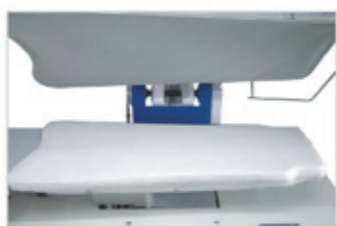
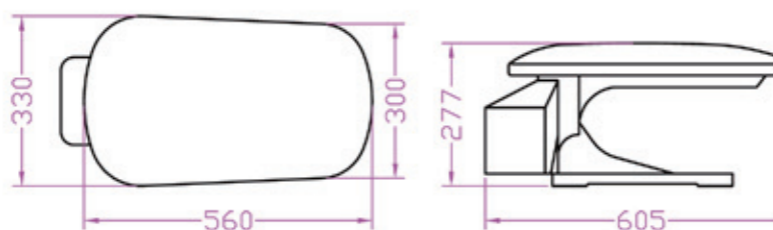

下模尺寸簡圖 Lower mould size  
(NS-8218, NS-8318, NS-8218P, NS-8318P, NS-8218AV & NS-8318AV)

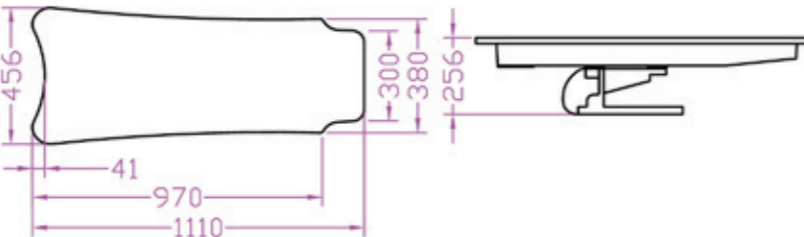

### 褲整熨及輔助設備下模易損件

### Wearing Parts of Lower Mould of Trousers Ironing & Assisting Equipment



褲頭A款耐高溫布套  
Nomex fabric cover of Topper A



褲頭B款耐高溫布套  
Nomex fabric cover of Topper B



褲頭C款耐高溫布套  
Nomex fabric cover of Topper C



褲頭D款耐高溫布套  
Nomex fabric cover of Topper D



耐高溫布套  
Nomex fabric cover



褲管壓平機耐高溫布套  
Nomex fabric cover of legger press

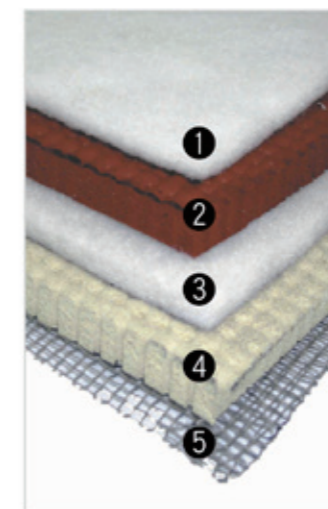

1. 白色高溫毛氈
2. 紅色矽膠壓氈
3. 高溫毛氈
4. 黃色矽膠壓氈
5. 光面不銹鋼網

1. White heat-resistant felt
2. Red perforated silicon foam
3. Heat-resistant felt
4. Yellow perforated silicon foam
5. Stainless steel mesh



白色高溫布  
White Nomex Fabric



白色高溫毛氈  
White heat-resistant felt



# 牛仔褲及衫表面處理設備

Jeans/Jacket Outlook Finishing Equipment

## NS-8813A-25

水濺式雙頭褲像噴藥機  
Water Curtain Chemical Spray Cabinet(Double Pants Dummy)



## NS-8813A-50

噴藥水濺櫃  
Chemical Spraying Cabinet



NS-8813A操作圖  
In working



NS-8813A選購件：  
橡膠褲像套備大碼(C17-RP-010-1-1)、  
中碼(C17-RP-010-1-2)、  
小碼(C17-RP-010-1-3)  
中小碼(C17-RP-010-1-4)  
供客戶選擇

Options:  
Large(C17-RP-010-1-1),  
middle(C17-RP-010-1-2),  
small(C17-RP-010-1-3)  
sized rubber trousers dummy and middle small  
sized rubber dummy(C17-RP-010-1-4)  
are available for selection



NS-4002-A噴槍  
(不銹鋼液道)  
Spray Gun(Stainless  
Steel Fluid Passage)  
適用於NS-8813A-  
25/NS-8813A-50/  
NS-8812A

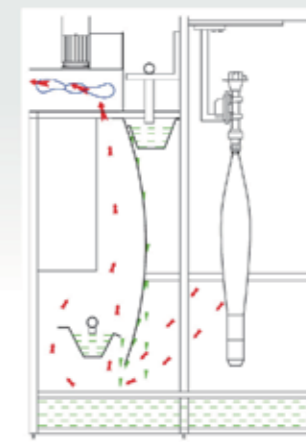

NS-8813A-25 &  
NS-8813A-50  
原理圖  
Principle Diagram

型號 Model	電源 Power Supply	風機功率 Fan Power (kW)	風機風量 (m <sup>3</sup> /hr) Air Flowrate of Exhaust Fan	水泵功率 Water Pump Power(kW)	水泵流量 (L/min) Flowrate of Water Pump	可選購褲像數量 Optional Trousers Dummy Quantit	壓縮空氣壓力 Compressed Air Pressure (kgf/cm <sup>2</sup> )	耗壓縮空氣量 (L/min.) Compressed Air Consumption	機身尺寸 Machine Size (cm)
NS-8813A-25	3PH/380V/50Hz	2.2x2	(2856~5281)x2	1.5	200	2	5	50	284x180x260

型號 Model	電源 Power Supply	風機功率 Fan Power (kW)	風機風量 (m <sup>3</sup> /hr) Air Flowrate of Exhaust Fan	水泵功率 Water Pump Power(kW)	水泵流量 (L/min) Flowrate of Water Pump	可選購褲像數量 Optional Trousers Dummy Quantit	壓縮空氣壓力 Compressed Air Pressure (kgf/cm <sup>2</sup> )	耗壓縮空氣量 (L/min.) Compressed Air Consumption	機身尺寸 Machine Size (cm)
NS-8813A-50	3PH/380V/50Hz	2.2x3	(2856~5281)x3	1.5	200x2	5	5	125	568x180x260*



# 牛仔褲及衫表面處理設備

Jeans/Jacket Outlook Finishing Equipment

## NS-8812A-25

水濺式雙頭人像噴藥機  
Water Curtain Chemical Spray Cabinet(Double Pants Dummy)



選購件: NS-8812A可選購不同  
碼數橡膠人像

Option : Optional Different Sized  
Rubber Dummy



NS-8512B 淨人像式噴藥機  
Monkey Spray Top Mannequin Frame Only



NS-8812A 操作圖 In working

※ 另有長袖供選擇  
Long sleeve type also available

型號 Model	電源 Power Supply	風機功率 Fan Power (kW)	風機風量 Air Flowrate of Exhaust Fan(m³/hr)	水泵功率 Water Pump Power(kW)	可選購人像數量 Optional Dummy Quantity	壓縮空氣壓力 Compressed Air Pressure(kgf/cm²)	耗壓縮空氣量 Compressed Air Consumption (L/min)	機身尺寸 Machine Size(cm)
NS-8812A-25	3PH/380V/50Hz	2.2x2	(2856~5281)x2	0.75	2	5	30	244x192x211
NS-8812A-50		2.2x3	(2856~5281)x3	0.75x2	4		60	488x192x211*

## NS-8320

自動電加熱式壓平機  
Automatic Electric Heated Press



NS-8320工作中  
In working



## NS-8118TE

全電加熱式褲管壓平機  
Totally Electric Heated Legger Press



NS-8118TE 模尺寸  
Mould Size



型號 Model	電源 Power Supply	總功率 Total Power (kW)	壓縮空氣壓力 Compressed Air Pressure(kgf/cm²)	耗壓縮空氣量 Compressed Air Consumption(L/min)	機身尺寸 Machine Size (cm)
NS-8118TE	3PH/380V/50Hz	9.1	5	150	157x165x205
NS-8320		7.7			160x104x167



### NS-8634

臥式褲像架  
Horizontal Trousers Frame



NS-8634  
褲管可自由旋轉，  
配合碟剎定位裝置，  
可滿足任意部位的磨褲需求  
Trousers could rotate  
freely, working  
together with the disc  
braking positioning  
device, suitable for  
brushing operation  
on any part of the  
trousers



NS-8634  
手擦牛仔褲，細緻效果好  
Manually jeans brushing, good effect

型號 Model	電源 Power Supply	總功率 Total Power(kW)	壓縮空氣壓力 Compressed Air Pressure(kgf/cm <sup>2</sup> )	耗壓縮空氣量 Compressed Air Consumption(L/min)	機身尺寸 Machine Size(cm)
NS-8634	1PH/220V/50Hz	0.2	5	30	155x71x105

### NS-8617

立式褲像架  
Vertical Trousers Frame



### NS-8619

立式磨褲機  
Vertical Trousers  
Brushing Machine



### NS-8630

多層手擦架  
Multi-buck Hand Brushing Stand



NS-8619 磨褲操作  
In grinding

型號 Model	電源 Power Supply	總功率 Total Power (kW)	壓縮空氣壓力 Compressed Air Pressure(kgf/cm <sup>2</sup> )	耗壓縮空氣量 Compressed Air Consumption(L/min)	機身尺寸 Machine Size (cm)
NS-8617	1PH/220V/50Hz	0.2	5	30	84x60x215
NS-8619	3PH/380V/50Hz	0.56		35	93x107x255
NS-8630	-	-	-	-	125x60x95



### NS-8623A

立體尖褶定型機  
3-D Pleating Machine



### NS-8632

牛仔褲推壓壓皺機  
Jeans Scrunch Machine



### NS-8622

立體打褶單頭定型機  
3-D Single-head Pleating Machine



### NS-8626

自動壓熨機  
Automatic Pressing Machine



NS-8623A 操作圖  
In working



NS-8623A 加工效果圖  
Finished



NS-8632 操作圖  
In working



NS-8622 操作圖  
In working



NS-8626 操作圖  
In working

型號 Model	電源 Power Supply	總功率 Total Power(kW)	最高溫度 Max. Temp. (°C)	壓縮空氣壓力 Compressed Air Pressure(kgf/cm <sup>2</sup> )	耗壓縮空氣量 Compressed Air Consumption(L/min)	機身尺寸 Machine Size (cm)
NS-8623A	1PH/220V/50Hz	3.2	200	5	20*	66x112x128
NS-8632	--	--	--		5	135x39x100

型號 Model	電源 Power Supply	總功率 Total Power(kW)	壓縮空氣壓力 Compressed Air Pressure(kgf/cm <sup>2</sup> )	耗壓縮空氣量 Compressed Air Consumption(L/min)	機身尺寸 Machine Size (cm)
NS-8622	3PH/380V/50Hz	3.8	5	100	71x100x210
NS-8626		3.9		150	104x110x167



### NS-2270

自動洗衣脫水機  
Automatic Washing Extractor



- 適用於棉、毛、麻、化纖等衣物洗滌用，系“懸浮式全自動洗衣機”，洗衣效果佳
- 採用PLC可編程控制器控制及人性化操作界面觸摸顯示屏操作，可記憶10段程式
- 採用變頻器控制，洗衣速度可調
- 採用蒸汽直接加熱，即時/到溫計時選擇
- 前置式設計，操作更便捷
- 不銹鋼內膽，經久耐用
- NS-2270系列採用懸浮式避振裝置，有效降低機器運轉時產生的振動
- NS-2270系列具有自動脫水功能，極大地節省人力並顯著地提高生產效率

- It is suitable for washing garments made of various fabrics such as cotton, wool, linen, chemical fiber, etc., it is a "Suspension Type Automatic Washing Machine" with fine washing effect
- Adopt PLC and user friendly touch screen for operation; it can memory 10 groups of program
- Adopt inverter control, the speed of washing is adjustable
- Heating directly by steam and users can select immediate or up-to temperature timing
- Front loading design for convenient operation
- The inner drum is made of stainless steel, durable
- NS-2270 series adopts suspension type vibration absorbing device for less vibration during machine running
- NS-2270 series of machines has automatic water extracting function, so it saves labor and improves working efficiency greatly

### 跟機件Standard :



控制電箱  
Control box



控制面板  
Control panel



單排水系統  
Single outlet water draining system



入水流量計  
Water inlet flowmeter

### 選購件Options :



最多可選購6個5升的藥水缸  
Up to six chemical dosing boxes of 5 liters volume can be purchased



氣動入熱水裝置 Pneumatic hot water inlet unit



雙排水系統 Double outlet water draining system

型號 Model	容量(kg) Capacity	電源 Power Supply	馬達 Motor (kW)	內膽尺寸(mm) Inner Drum Size	外膽尺寸(mm) Outer Drum Size	撥掌高x厚度 Beater Height x thickness(mm)	最高脫水速度 Max. Extracting Speed(RPM)	洗衣速度 Washing Speed(RPM)	機身尺寸(cm) Machine Size
NS-2270-30	30	3PH/380V/50Hz	3	Ø900x450x2	Ø990x550	110x2	500	10~35	160x150x200
NS-2270-50	50		4	Ø1080x625x2	Ø1200x735	120x2			185x165x190*
NS-2270-80	80		7.5	Ø1200x750x3	Ø1280x910	140x3	200x211x215		
NS-2270-160	160		15	Ø1470x960x3	Ø1540x1070	145x3	198x235x211		



### NS-2272

自動洗衣機  
Automatic Washing Machine



- NS-2272-550-T內膽孔位外凸式設計，適合洗滌襯衫、T恤衫等薄料衣物
- NS-2272-550-H內膽圍板可更換，適合洗滌牛仔等厚料衣物
- 前置式設計，內膽採用齒輪變速直接傳動，無傳動損耗
- 備氣動入水和氣動排水功能，配合PLC可實現自動化生產
- 採用變頻器調速洗衣速度可調，滿足多種洗滌要求
- 帶流量計可準確控制水位
- 機身可傾斜，方便自動倒料，減少人工
- NS-2272-550-T: Protruding perforation design of inner drum for washing thin materials as shirt, T-shirt, etc.
- NS-2272-550-H: Replaceable surrounding plate of inner drum for washing thick materials as jeans, etc.
- Front loading design and direct drive via gear shift of the inner drum without driving loss
- Pneumatic water feeding and draining function, working together with PLC realizes automatic production
- Variable wash speed adjusted by frequency converter for meeting different washing requirements
- With flowmeter for more accurate water level control
- The machine body could tilt for garment unloading automatically so as to save labor



可傾斜卸料系統（跟機件）  
Tiltable system for garment unloading (standard)



自動入藥系統（選購件）  
Automatic chemical feeding system(option)



入水流量計（跟機件）  
Water inlet flowmeter (standard)

型號 Model	內膽容積(m <sup>3</sup> ) Inner Drum Capacity	電源 Power Supply	馬達 Motor (kW)	內膽尺寸(mm) Inner Drum Size	外膽尺寸(mm) Outer Drum Size	撥掌(厚度x個數) Beater (thickness x quantity)	洗滌速度 Washing Speed(RPM)
NS-2272-360-T	3.6	3PH/380V/50Hz	15	Ø1800x1450x3	Ø1897x1776x3	單層 Single layer 6x6	12~38
NS-2272-360-H				Ø1800x1450x5	Ø1897x1776x3	雙層 double layer 6x6	12~38
NS-2272-550-T	5.5		18.5	Ø1994x1640x3	Ø2091x1906x3	單層 single layer 6x6	12~38
NS-2272-550-H				Ø1994x1640x5	Ø2091x1906x3	雙層 double layer 6x6	12~38





### NS-2712-20/30/50

工業洗衣機  
Industrial Washing Machine



### NS-2713-20/30/50

工業洗衣機  
Industrial Washing Machine



### NS-2700-450/500/650 NS-2701-450/500/650

工業洗衣機  
Industrial Washing Machine



#### 選購件 Options:

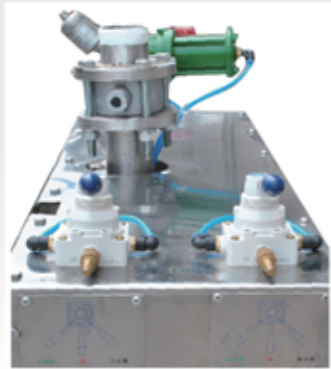

氣動入水  
pneumatic water feeding device



氣動排水  
pneumatic water draining device

NS-2712-20/30/50  
采用直接加熱  
Adopt direct heating up mode

NS-2713-20/30/50  
采用直接加熱加間接加熱的方式  
Adopt direct heating and indirect heating up modes

NS-2712-20/30/50及  
NS-2713-20/30/50  
不帶剎車系統  
without braking system



NS-2701間接加熱管  
Indirect Heating Pipe

NS-2700 系列采用直接加熱  
Adopt direct heating up mode

NS-2701系列采用直接加熱  
加間接加熱的方式  
Adopt direct heating and indirect heating up modes

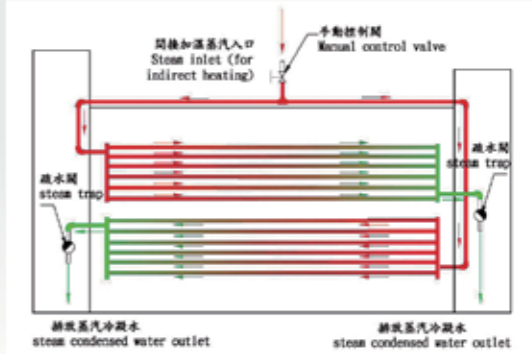

蒸汽間接加溫示意圖  
Indirect Steam Heating Diagram

型號 Model	容量(lbs) Capacity	電源 Power Supply	馬達 Motor (kW)	內膽尺寸(mm) Inner Drum Size	外膽尺寸(mm) Outer Drum Sizes	水容量 (L)Water Capacity	入水口 Water Inlet	出水口 Water Outlet	耗蒸汽量 (kg/hr) Steam Consumption	機身尺寸(cm) Machine Size
NS-2712-20	20	3PH/380V/50Hz	0.75	Ø730x250x1.2	Ø830x380x1.5	103	2"x1pc.	5"x1pc.	12	100x103x160
NS-2713-20						111				
NS-2712-30	30			Ø730x380x1.2	Ø830x500x1.5	135				
NS-2713-30						146				
NS-2712-50	50			Ø730x630x1.2	Ø830x760x1.5	206				
NS-2713-50						221				

型號 Model	容量(lbs) Capacity	電源 Power Supply	馬達 Motor (kW)	內膽尺寸(mm) Inner Drum Size	外膽尺寸(mm) Outer Drum Size	水容量(L) Water Capacity	機身尺寸(cm) Machine Size
NS-2700-450	450	3PH/380V/50Hz	7.5	Ø1100x2260x3	Ø1250x2440x2	1497	324x173x177
NS-2701-450						1573	
NS-2700-500	500		11	Ø1220x2260x4	Ø1370x2440x2	1798	
NS-2701-500						1882	
NS-2700-650	650		11	Ø1370x2260x4	Ø1500x2440x2	2185	
NS-2701-650						2277	



### NS-2275-160

自動洗衣染色機  
Automatic Washing  
& Dyeing Machine



### NS-2275-5

自動洗衣染色機  
Automatic Washing &  
Dyeing Machine



型號 Model	內膽容積 (m <sup>3</sup> ) Inner Drum Capacity	電源 Power Supply	總功率(kW) Total Power	內膽尺寸(mm) Inner Drum Size	最高脫水速度 Max. Spinning Speed(RPM)	洗衣速度 (RPM) Washing Speed	蒸汽壓力 (kgf/cm <sup>2</sup> ) Steam Pressure	壓縮空氣壓力 (kgf/cm <sup>2</sup> ) Compressed Air Pressure	機身尺寸(cm) Machine Size
NS-2275-5	0.05	3PH/380V/50Hz	8.5	Ø520x250	/	10~35	3~5	5	108x98x170
NS-2275-160	1.6		18.5	Ø1460x960	400				330x320x290

### NS-2261P

工業自動洗衣機  
Automatic Industrial Washing Machine



#### 選購件 Options:



可選購藥水配量缸(NS-2291)  
Users can select a Chemical Dosing Tank(NS-2291)  
to work together

- 適用於工業洗衣，酵洗，牛仔、針織恤衫洗滌、染色
- 配備可編程序控制器，採用觸摸屏控制
- 自動/氣動入水，排水，入蒸汽供選擇
- 氣動剎車裝置，停機後內門對外門自動控制
- 採用無段變速的變頻器，速度可調(8~36RPM)
- Suitable for industrial washing, ferment washing, jeans, knitted shirts washing and dyeing
- Equipped with PLC, adopting touch screen control
- Automatic or pneumatic water inlet, water drainage and steam intake
- Pneumatic braking device, inner door could align with outer door automatically after stopping running
- Inverter for stepless speed control, speed range:8-36rpm

型號 Model	電源 Power Supply	馬達(kW) Motor	內膽尺寸(mm) Inner Drum Size	外膽尺寸(mm) Outer Drum Sizes	耗蒸汽量(kg/hr) Steam Consumption	水容量(L) Water Capacity	洗衣速度 (RPM) Washing Speed	機身尺寸(cm) Machine Size
NS-2261P-450	3PH/380V/50H	7.5	Ø1100x2260x3	Ø1250x2440x2	170	1573	8~36	324x173x177
NS-2261P-500		11	Ø1220x2260x4	Ø1370x2440x2	200	1882		328x186x200
NS-2261P-650		11	Ø1370x2260x4	Ø1500x2440x2	260	2289		327x199x207



### NS-2273-80

毛衫洗衣脫水機  
Sweater Washing Extractor



氣動排毛頭裝置  
Pneumatic foam removal device

兩個微清水回收  
水箱(跟機件)  
Two rinsed  
water recycling  
tanks(standard)

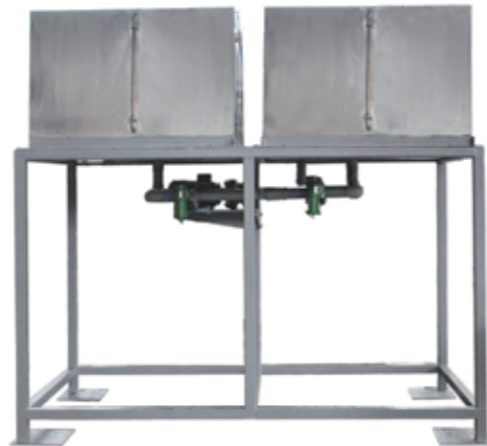

型號 Model	內膽容積 (m <sup>3</sup> ) Inner drum	電源 Power Supply	內膽馬達功率(kW) Motor Power of Inner drum	最高脫水速度(RPM) Max. Spinning Speed	洗衣速度(RPM) Washing Speed	內膽尺寸(mm) Inner Drum Size	機身尺寸(cm) Machine Size
NS-2273-80	0.8	3PH/380V/50Hz	7.5	300	10~30	Ø1200x750	191x202x215

### NS-2500

工業脫水機連電子變速及時間剎車  
Industrial Extractor with Frequency Speed Control and Timer Brake Stop



控制面板  
Control panel



工作中  
In working

型號 Model	容量(lbs) Capacity	電源 Power Supply	內膽馬達功率(kW) Motor Power of Inner drum	最高脫水速度(RPM) Max. Spinning Speed	內膽尺寸(mm) Inner Drum Size	機身尺寸(cm) Machine Size
NS-2500-55	55	3PH/380V/50Hz	3	1200	Ø635x290	135x104x85
NS-2500-130	130		5.5	1060	Ø915x360	177x126x95
NS-2500-200	200		7.5	940	Ø1067x360	206x158x106
NS-2500-260	260		11	810	Ø1220x380	230x174x110



### NS-2801-3-S

節能乾衣機  
Energy Saving Drying Tumbler

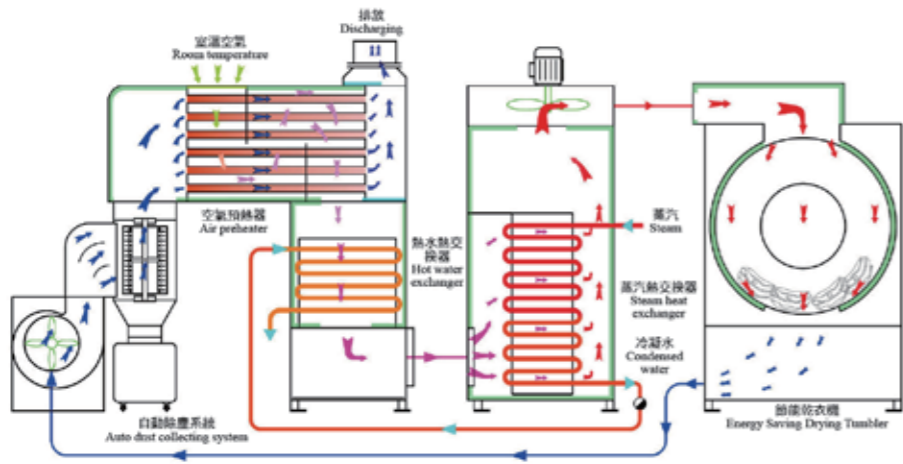

機身可傾斜倒料  
Tiltable machine body for garment unloading

型號 Model	內膽容積 (m <sup>3</sup> ) Inner Drum Capacity	電源 Power	總功率(kW) Total Power	風機功率 (kW) Fan Power	主軸轉動馬達功率 (kW) Main Motor Power	耗蒸汽量 (kg/hr) Steam Consumption	壓縮空氣壓力 (kgf/cm <sup>2</sup> ) Compressed Air Pressure	內膽尺寸 (mm) Inner Drum Size	機身尺寸(cm) Machine Size
NS-2801-3-S	3	3PH/380V/50Hz	7	2.2x2	2.2	75~120	5	Ø1778x1194	317x266x315

### NS-2801-4-S

節能乾衣機  
Energy Saving Drying Tumbler



- NS-2801A-4 前門入料·前門出料
- NS-2801B-4 前門入料·後門出料
- NS-2801A-4 adopts front loading and front unloading design
- NS-2801B-4 adopts front loading and back unloading design

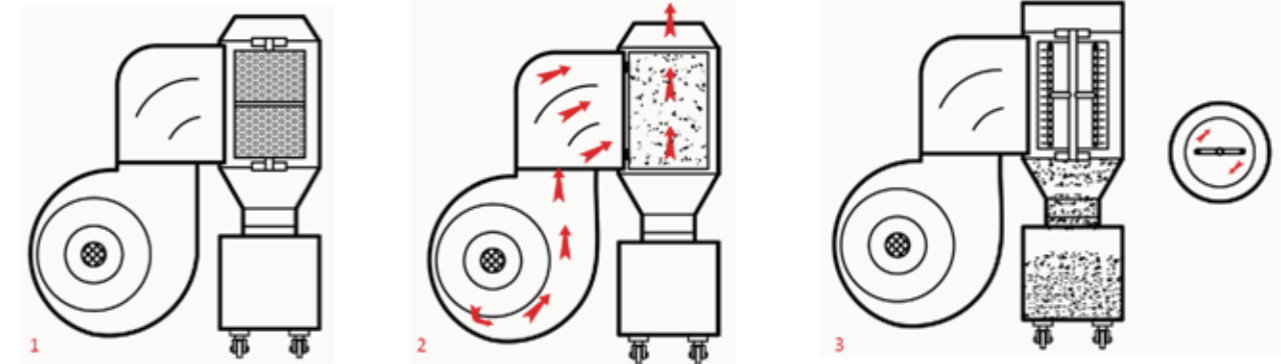

自動環保除塵過濾系統工作原理  
Work principle of environment-friendly automatic de-dusting & filtering system

型號 Model	內膽容積 (m <sup>3</sup> ) Inner Drum Capacity	加熱方式 Heating Mode	電源 Power Supply	主軸轉動馬達功率(kW) Main Motor Power	抽風馬達功率 (kW) Vacuum Motor Power	壓縮空氣壓力 (kgf/cm <sup>2</sup> ) Compressed Air Pressure	內膽尺寸 (mm) Inner Drum Size	機身尺寸(cm) Machine Size
NS-2801A-4-S	4	蒸汽熱型 Steam heated	3PH/380V/50Hz	5.5	7.5+2.2	5	Ø1480x2335	316x332x342
NS-2801A-4-G		瓦斯熱型 Gas heated						
NS-2801A-4-O		油熱型 Oil heated						
NS-2801B-4-S		蒸汽熱型 Steam heated						
NS-2801B-4-G		瓦斯熱型 Gas heated						
NS-2801B-4-O		油熱型 Oil heated						



### NS-2805-5.5

工業乾衣機  
Industrial Drying Tumbler

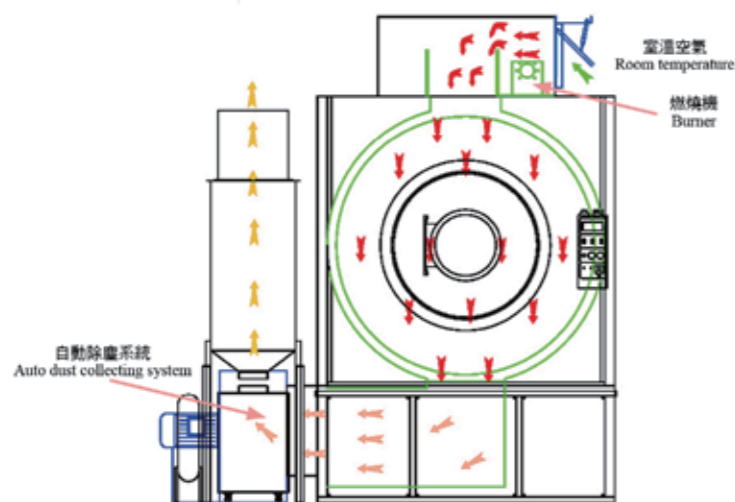

機身可傾斜倒料  
Tilttable machine body for garment unloading

型號 Model	內膽容積 (m <sup>3</sup> ) Inner Drum Capacity	加熱方式 Heating Mode	電源 Power Supply	內膽馬達功率 (kW) Motor Power of Inner drum	抽風馬達功率 (kW) Vacuum Motor Power	內膽尺寸(mm) Inner Drum Size	機身尺寸(cm) Machine Size		
NS-2805-3-S	3	蒸汽熱型 Steam heated	3PH/380V/50Hz	2.2	2.2	Ø1778x1194	318x230x306		
NS-2805-3-G		瓦斯熱型 Gas heated							
NS-2805-3-O		油熱型 Oil heated							
NS-2805-5.5-S	5.5	蒸汽熱型 Steam heated		5.5	7.5			Ø1880x1910	337x326x342
NS-2805-5.5-G		瓦斯熱型 Gas heated							
NS-2805-5.5-O		油熱型 Oil heated							

### NS-2806-4

工業乾衣機  
Industrial Drying Tumbler

- 適用於烘干各種棉織、牛仔、梳織、針織、化纖等衣物
- NS-2806A-4 前門入料，前門出料
- NS-2806B-4 前門入料，後門出料，前後採用升降門設計

- Suitable for drying garments made of various fabrics such as cotton, jeans, woven fabric, knitted fabric, synthetic textile, etc.
- NS-2806A-4 adopts front loading and front unloading design
- NS-2806B-4 adopts front loading and back unloading design and the front and back door could lift up and down automatically

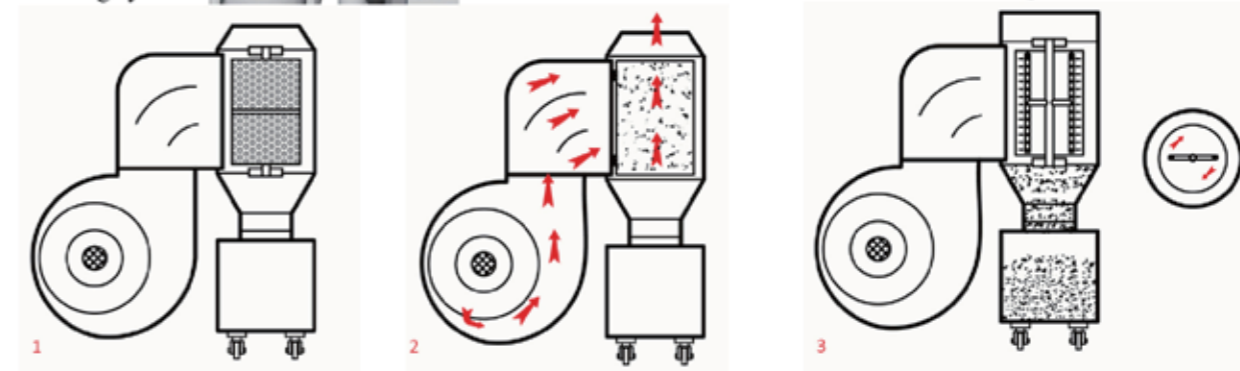
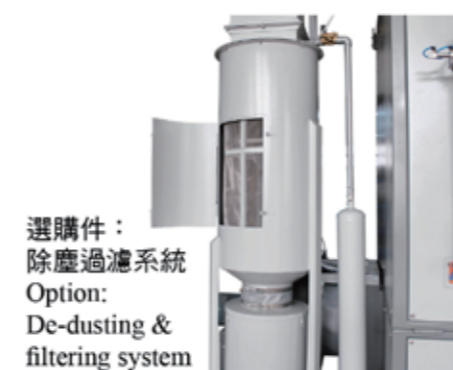

自動環保除塵過濾系統工作原理 (選購件)  
Work principle of environment-friendly automatic de-dusting & filtering system (Option)

型號 Model	內膽容積 (m <sup>3</sup> ) Inner Drum Capacity	加熱方式 Heating Mode	電源 Power Supply	總功率(kW) Total Power	內膽馬達 (kW) Inner Drum Motor Power	抽風馬達(kW) Vacuum Motor Power	壓縮空氣壓力 (kgf/cm <sup>2</sup> ) Compressed Air Pressure	內膽尺寸 (mm) Inner Drum Size
NS-2806A-4-S	4	蒸汽熱型 Steam heated	3PH/380V/50Hz	11.2	5.5	5.5	5	Ø1480x2335
NS-2806A-4-G		瓦斯熱型 Gas heated						
NS-2806A-4-O		油熱型 Oil heated						
NS-2806B-4-S		蒸汽熱型 Steam heated						
NS-2806B-4-G		瓦斯熱型 Gas heated						
NS-2806B-4-O		油熱型 Oil heated						



### UNI-2800-40

工業乾衣機  
Industrial Drying Tumbler



- 適合酒店洗衣行業
- suitable for hotel laundry industry

### NS-2800

工業乾衣機  
Industrial Drying Tumbler

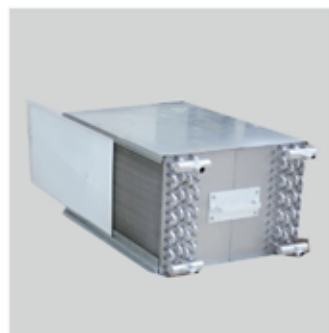

蒸汽熱交換器 (S)  
Steam heat exchanger

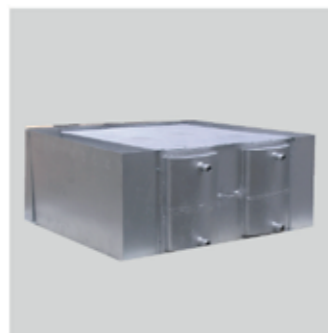

油熱交換器 (O)  
Oil heat exchanger



瓦斯熱交換器 (G)  
Gas heat exchanger

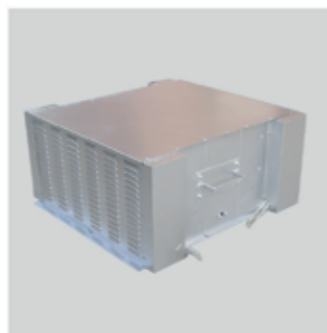

電熱交換器 (E)  
Electric heat exchanger

蒸汽熱型號 Steam Heat Model	UNI-2800-40-S	NS-2800-50-S	NS-2800-70-S	NS-2800-100-S	NS-2800-200-S	NS-2800-300-S
容量(Capacity)	40 kg	50 lbs	70 lbs	100 lbs	200 lbs	300 lbs
內膽尺寸(Inner Drum Size) mm	Ø1118x864x1.5	Ø965x533x1.5	Ø965x864x1.5	Ø1118x864x1.5	Ø1372x1041x1.5	Ø1778x1016x1.5
內膽容積(Inner Drum Capacity)	0.85 m <sup>3</sup>	0.39 m <sup>3</sup>	0.64 m <sup>3</sup>	0.86 m <sup>3</sup>	1.54 m <sup>3</sup>	2.54 m <sup>3</sup>
耗蒸汽量(Steam Consumption)	60 kg/hr	30 kg/hr	45 kg/hr	60 kg/hr	120 kg/hr	180 kg/hr
內膽馬達功率(Motor Power of Inner Drum)	1.1 kW	1.1 kW	1.1 kW	1.1 kW	2.2 kW	4 kW
排風馬達功率(Air Extracting Motor Power)	1.5 kW	1.5 kW	1.5 kW	1.5 kW	2.2 kW	2x2.2 kW
電總功率(Total Power)(3PH/380V/50Hz)	2.8 kW	2.8 kW	2.8 kW	2.8 kW	4.6 kW	8.6 kW
內膽轉速(Rotation Speed of Inner Drum)	27 r/min	27 r/min	27 r/min	27 r/min	25 r/min	22 r/min
機身尺寸(Machine Size) cm	122x167x205	105x120x195	105x154x195	122x167x205	147x180x201	186x206x225

電熱型號 Electric Heat Model	UNI-2800-40-E	NS-2800-50-E	NS-2800-70-E	NS-2800-100-E
容量(Capacity)	40 kg	50 lbs	70 lbs	100 lbs
內膽尺寸(Inner Drum Size) mm	Ø1118x864x1.5	Ø965x533x1.5	Ø965x864x1.5	Ø1118x864x1.5
內膽容積(Inner Drum Capacity)	0.85 m <sup>3</sup>	0.39 m <sup>3</sup>	0.64 m <sup>3</sup>	0.86 m <sup>3</sup>
內膽馬達功率(Motor Power of Inner Drum)	1.1 kW	1.1 kW	1.1 kW	1.1 kW
排風馬達功率(Air Extracting Motor Power)	1.5 kW	1.5 kW	1.5 kW	1.5 kW
發熱線功率(Heater Power)	11.7* kW	4.8* kW	11.7* kW	11.7* kW
電總功率(Total Power)(3PH/380V/50Hz)	14.5 kW	7.6 kW	14.5 kW	14.5 kW
內膽轉速(Rotation Speed of Inner Drum)	27 r/min	27 r/min	27 r/min	27 r/min
機身尺寸(Machine Size) cm	122x167x205	105x120x195	105x154x195	122x167x205

瓦斯熱型號 Gas Heat Model	NS-2800-100-G	NS-2800-200-G	NS-2800-300-G
容量(Capacity)	100 lbs	200 lbs	300 lbs
內膽尺寸(Inner Drum Size) mm	Ø1118x864x1.5	Ø1372x1041x1.5	Ø1778x1016x1.5
內膽容積(Inner Drum Capacity)	0.86 m <sup>3</sup>	1.54 m <sup>3</sup>	2.54 m <sup>3</sup>
石油氣消耗量(LPG Consumption)	3.7kg/hr.	7.4kg/hr.	11.1kg/hr.
天然氣消耗量(Natural Gas Consumption)	4.8 m <sup>3</sup> /hr.	9.6 m <sup>3</sup> /hr.	14.4 m <sup>3</sup> /hr.
內膽馬達功率(Motor Power of Inner Drum)	1.1 kW	2.2 kW	4 kW
排風馬達功率(Air Extracting Motor Power)	1.5 kW	2.2 kW	2x2.2 kW
電總功率(Total Power)(3PH/380V/50Hz)	2.8 kW	4.6 kW	8.6 kW
內膽轉速(Rotation Speed of Inner Drum)	27 r/min	25 r/min	22 r/min
機身尺寸(Machine Size) cm	122x167x205	147x180x201	186x206x225

油熱型號 Oil Heat Model	NS-2800-100-O	NS-2800-200-O	NS-2800-300-O
容量(Capacity)	100 lbs	200 lbs	300 lbs
內膽尺寸(Inner Drum Size) mm	Ø1118x864x1.5	Ø1372x1041x1.5	Ø1778x1016x1.5
內膽容積(Inner Drum Capacity)	0.86 m <sup>3</sup>	1.54 m <sup>3</sup>	2.54 m <sup>3</sup>
熱能消耗量(Heat Consumption)	33480 kcal/hr.	66960 kcal/hr.	100440 kcal/hr.
內膽馬達功率(Motor Power of Inner Drum)	1.1 kW	2.2 kW	4 kW
排風馬達功率(Air Extracting Motor Power)	1.5 kW	2.2 kW	2x2.2 kW
電總功率(Total Power)(3PH/380V/50Hz)	2.8 kW	4.6 kW	8.6 kW
內膽轉速(Rotation Speed of Inner Drum)	27 r/min	25 r/min	22 r/min
機身尺寸(Machine Size) cm	122x167x205	147x180x201	186x206x225



### NS-2630

分石機  
Stone Separator



### NS-2810

熱風乾布樣板機  
Hot Air Fabric Sample Machine



### NS-2810-1

熱風乾布樣板機  
Hot Air Fabric Sample Machine



型號 Model	電源 Power Supply	總功率 (kW) Total Power	壓縮空氣壓力 (kgf/cm <sup>2</sup> ) Compressed Air Pressure	耗壓縮空氣量 (L/min) Compressed Air Consumption	蒸汽壓力 (kgf/cm <sup>2</sup> ) Steam Pressure	耗蒸汽量(kg/hr) Steam Consumption	內膽尺寸(mm) Inner Drum Size	機身尺寸(cm) Machine Size
NS-2630		5.7	5	10	--	--	Ø1480x2300	228x277x317
NS-2810	3PH/380V/50Hz	2.6	--	--	3~5	15	--	162x93x119
NS-2810-1		2.4	--	--				108x102x107

### 洗衣機、干衣機附件 Washing machine and drying machine options

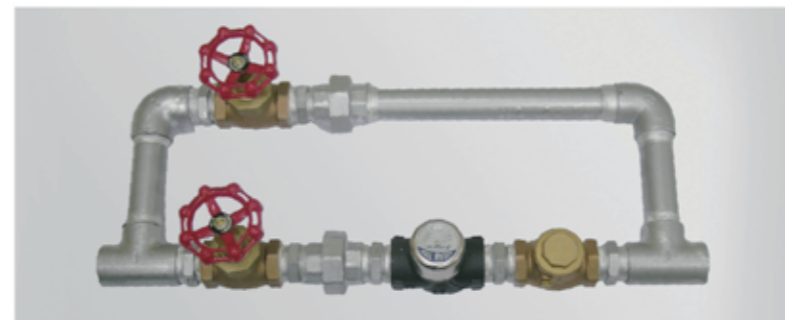

疏水閥總承(管徑規格: 1/2", 1")  
Steam trap set(pipe diameter :1/2", 1")

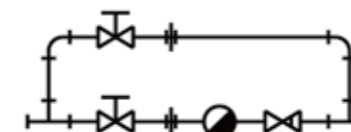

蒸汽氣動閥總承  
Steam pneumatic valve set

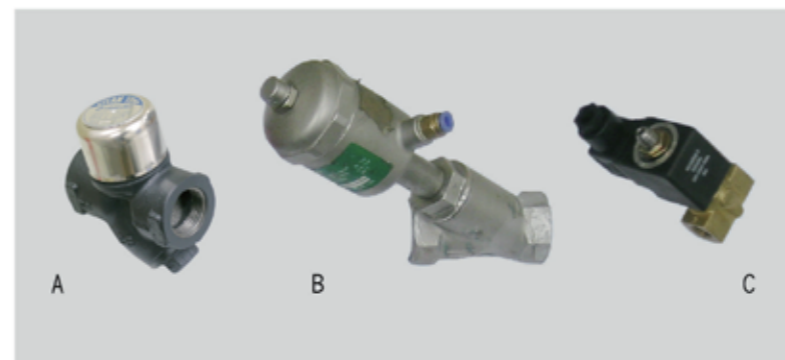
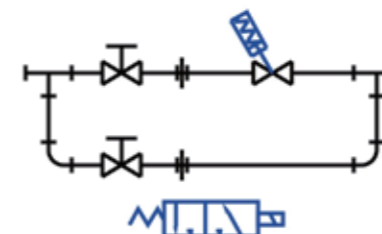

A: 蒸汽疏水閥 Steam trap  
B: 蒸汽氣動閥 Steam pneumatic valve  
C: 三路制 3-way valve

### 洗衣機內膽種類 CYLINDER CONFIGURATION



P1  
One door-單門  
One pocket 單內膽



P3  
Two doors, with middle partition-  
雙門中分  
Two Pockets雙內膽



P5  
Two doors 雙門  
One pocket 單內膽  
Standard Type 標準型

\* 標準型  
Standard: P1、P5  
\* 選購型  
Option: P3



# 夾縫落樸防皺粘合壓平機

Seam Fusing Machine

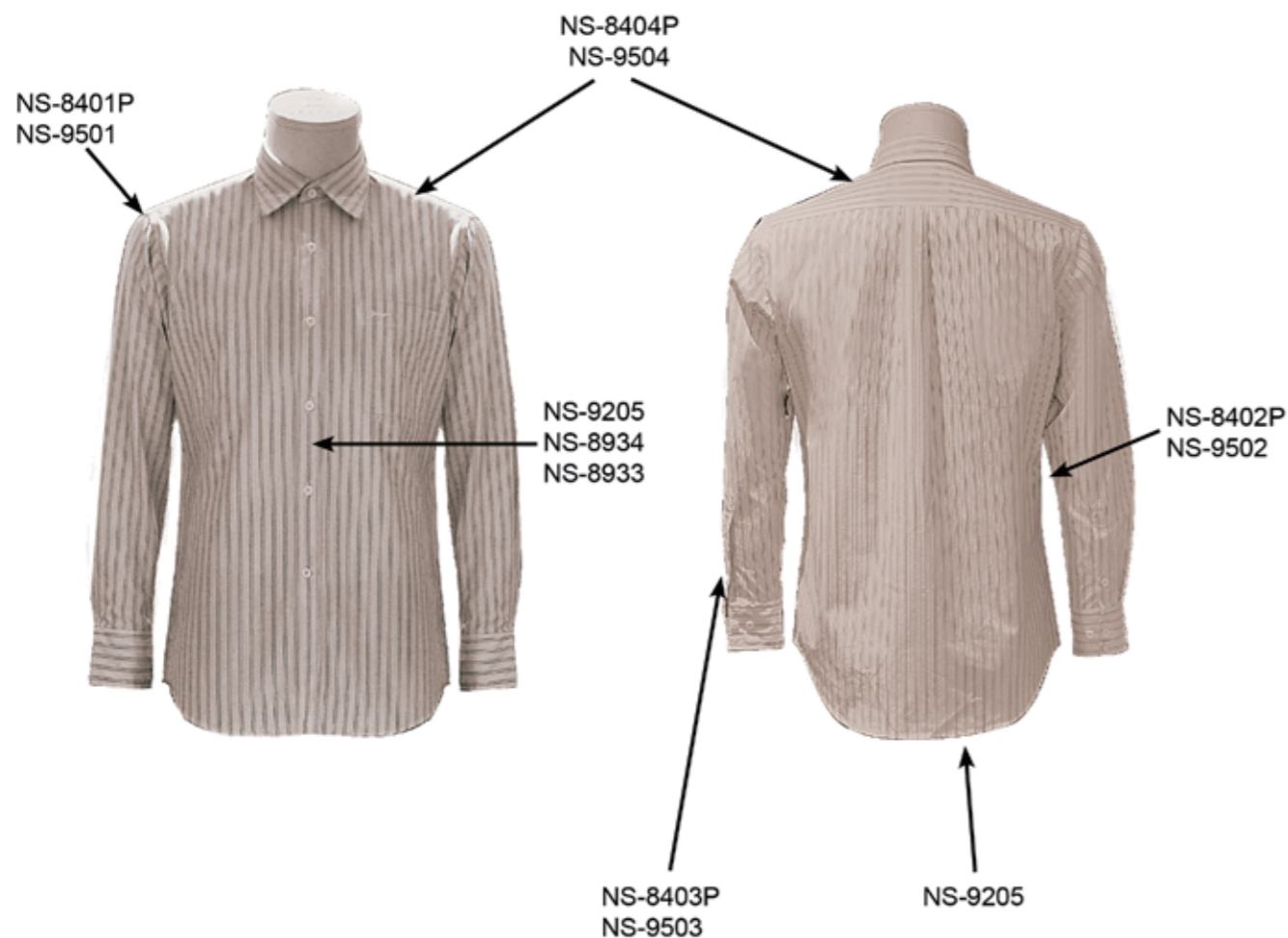

Seam pucker free production : Sewing operators have to insert interlining during the sewing process especially on the shirts Placket, Plait Placket, Armhole, Side Seam, York, Shoulder, Pocket, Triangular Sleeve, Bottom hem, etc. By using the specially designed fusing machines to fuse the sewn fabric with interlining, the seam parts will become smooth and it enhances the shape of shirt as well.

線縫防皺生產：車縫操作員需在縫車步驟里加上膠樸，特別在襯衫的明筒，鈕子，袖衫，側縫，擔桿，納膊，前袋，側袖，拉腳等位置。本公司設計了一系列粘合機，專門解決車縫所產生的褶皺問題，使線縫平滑，特顯襯衫立體感。

Illustration of Fusing Machine Code Standard  
線縫粘合機的代碼說明

- NS-82XX 槓桿式壓平機 Lever Pressing Machine
- NS-84XX 垂直加壓式壓平機 Vertical Pressing Machine
- NS-89XX 轉頭式壓平機 Rotation Head Pressing Machine
- NS-92XX 龍門架移頭下加壓式壓平機 Enforced Body Vertical Pressing Machine(Pressure from Top)
- NS-94XX 龍門架垂直加壓式壓平機 Enforced Body Vertical Pressing Machine(Pressure from Bottom)
- NS-95XX 龍門架轉頭式壓平機 Enforced Body Rotation Head Pressing Machine

## NS-9501

自動轉頭袖山縫壓平機  
Automatic Rotation Arm Hole Press



硅膠 Silica Rubber 氣袋 Air Bag

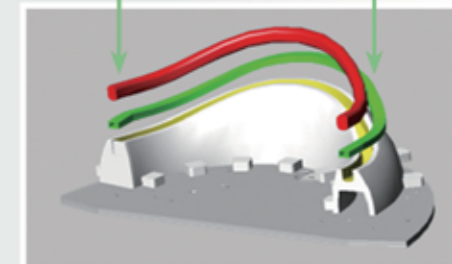

特別設計下模，徹底消除模與襯衫袖山縫形狀間的偏差  
Special design for the lower mould to off set the shape tolerance between the mould and the armhole



適用於袖山縫粘合壓熨  
Suitable for armhole fusing and ironing

## NS-8401P

自動袖衫袖山縫壓平機  
Automatic Shirt Arm Hole Press



F225-DNC  
單針袖落樸蝴蝶—雙針鎖鏈底車用  
Single Needle Sleeve Attachment with Interlining - Double Needle Chain Stitch Operation

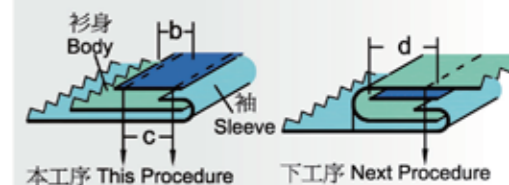

型號 Model	電源 Power Supply	總功率(kW) Total Power	壓縮空氣壓力(kgf/cm <sup>2</sup> ) Compressed Air Pressure	耗壓縮空氣量(L/min) Compressed Air Consumption	機身尺寸(cm) Machine Size
NS-8401P	3PH/380V/50Hz	3.7	5	120	117x85x215
NS-9501		3.9		180	152x150x192





# 夾縫落樸防皺粘合壓平機

## Seam Fusing Machine

### NS-9502

自動轉頭側縫壓平機  
Automatic Rotation  
Side Seam Press



### F232

單針落樸埋夾蝴蝶—單針車  
Single Needle Side Seam Folder with  
Interlining - Single Needle Machine

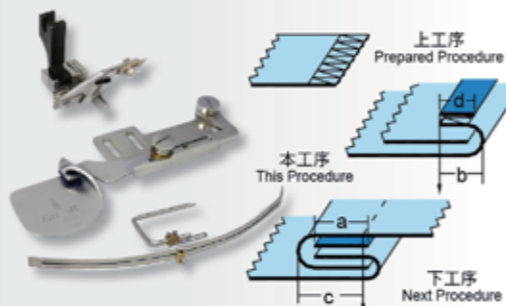

NS-9502 工作中  
In Working

### NS-9512

自動轉頭公主褶壓平機  
Automatic Rotation Princess Seam Press

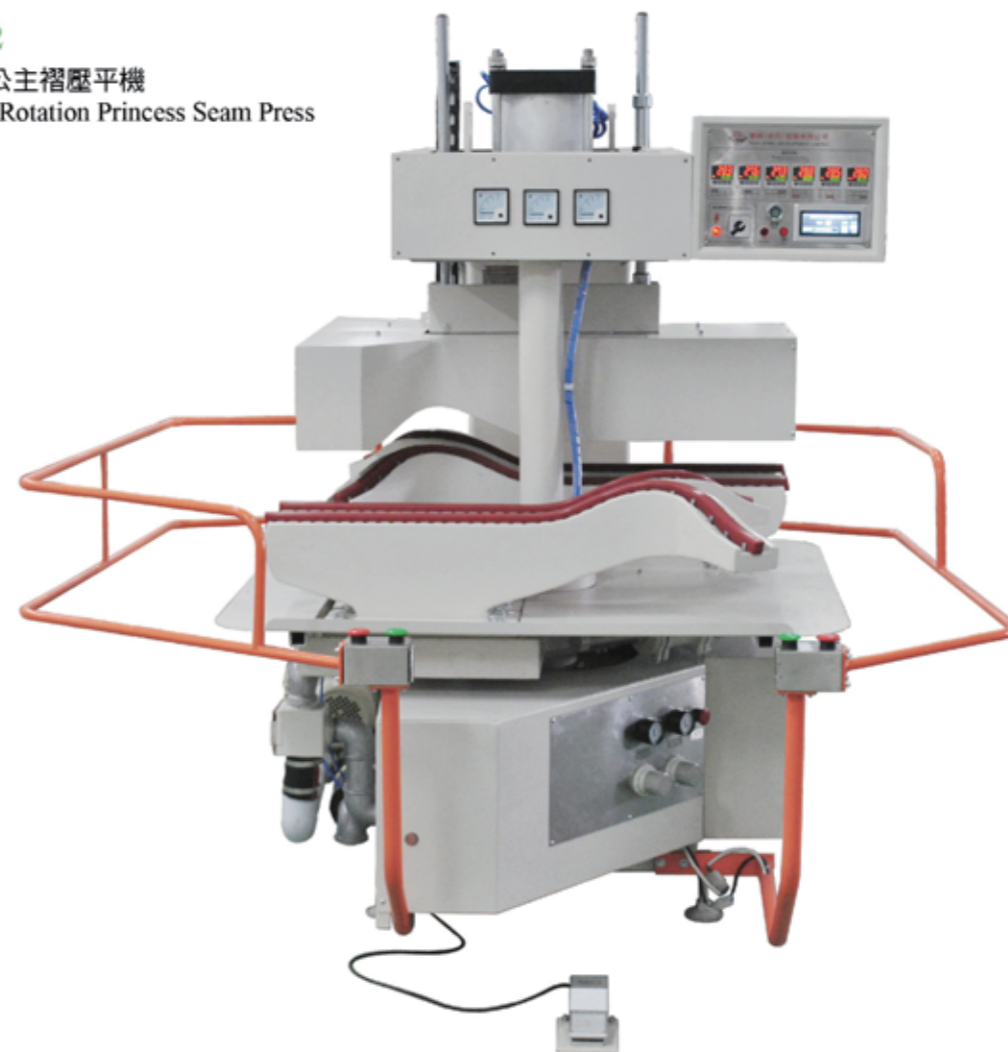

### NS-8402P

自動袖衫側縫壓平機  
Automatic Sleeve Side  
Seam Press



### F236

日字埋夾落樸蝴蝶  
Side Seam Folder with Interlining -  
Japan Style

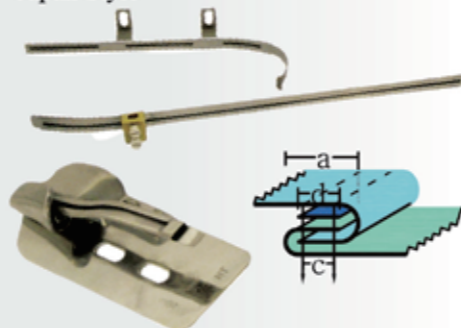

NS-8402P 工作中  
In Working

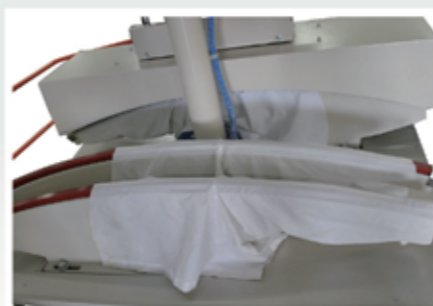

NS-9502 D款模工作中  
D type mould in working



NS-9512 工作中  
In working



NS-9512下模硅膠條可左右微調  
Silica rubber of lower mould can be  
adjusted right and left slightly

型號 Model	電源 Power Supply	總功率(kW) Total Power	壓縮空氣壓力 (kgf/cm <sup>2</sup> ) Compressed Air Pressure	耗壓縮空氣量(L/min) Compressed Air Consumption	機身尺寸(cm) Machine Size
NS-8402P	3PH/380V/50Hz	6.3	5	120	151x95x215
NS-9502		6.7		180	175x187x198

型號 Model	電源 Power Supply	總功率(kW) Total Power	平均粘合壓力(kgf/cm <sup>2</sup> ) Average Fusing Pressure	最高設計溫度(°C) Max. Design Temp.	壓縮空氣壓力(kgf/cm <sup>2</sup> ) Compressed Air Pressure	機身尺寸(cm) Machine Size
NS-9512	3PH/380V/50Hz	7.5	5	200	5	150x167x160



# 夾縫落樸防皺粘合壓平機

## Seam Fusing Machine

### NS-9503

自動轉頭雙側袖筒壓平機  
Automatic Rotation  
Sleeve Placket Press



NS-8403P 適用於側袖粘合壓熨  
Suitable for fusing and pressing shirt  
sleeve placket



### NS-9504

自動轉頭擔杆壓平機  
Automatic Rotation Yoke Press

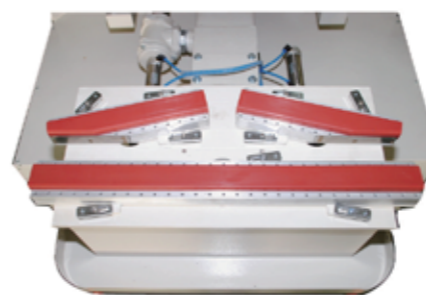

下模可調校，能滿足不同尺碼衣物需求  
Adjustable lower mold for different sized garment



### NS-8403P

雙頭側袖筒壓平機  
Sleeve Placket Press  
Double Head



### F230

側袖落樸落樸蝴蝶(選購件)  
Sleeve Placket Binder with  
Interlining(OPTIONS)

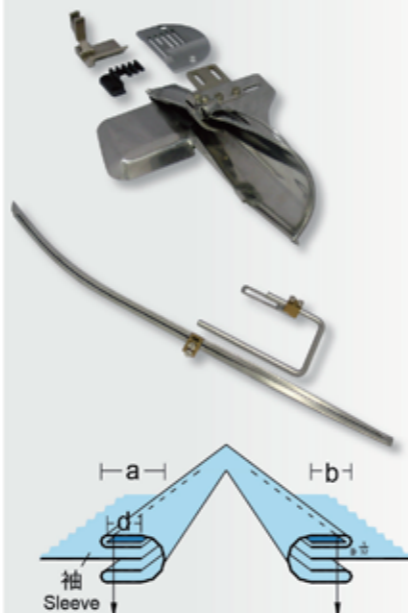

### NS-8404P

自動擔杆壓平機  
Automatic Shirt Yoke Press



### F228

單針納膊落樸蝴蝶  
Single Needle Shoulder Top Stitch  
Attachment with Interlining

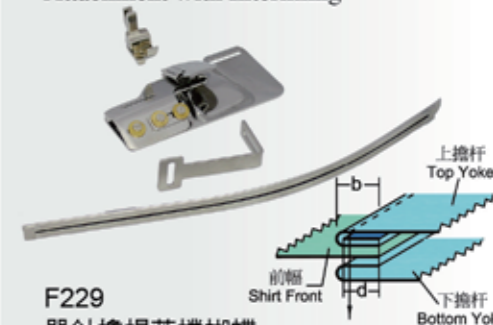

### F229

單針擔桿落樸蝴蝶  
Single Needle Shoulder Yoke Stitch  
Attachment with Interlining

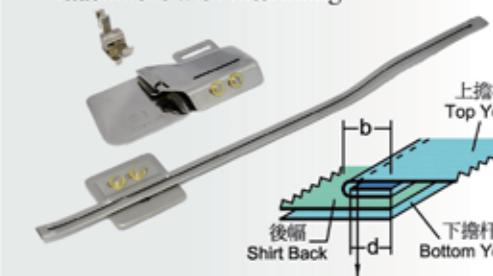

型號 Model	電源 Power Supply	總功率(kW) Total Power	壓縮空氣壓力(kgf/cm <sup>2</sup> ) Compressed Air Pressure	耗壓縮空氣量(L/min) Compressed Air Consumption	機身尺寸(cm) Machine Size
NS-8403P	3PH/380V/50Hz	4.2	5	100	106x93x215
NS-9503		3.4		180*	153x152x194

型號 Model	電源 Power Supply	總功率(kW) Total Power	壓縮空氣壓力(kgf/cm <sup>2</sup> ) Compressed Air Pressure	耗壓縮空氣量(L/min) Compressed Air Consumption	機身尺寸(cm) Machine Size
NS-8404P	3PH/380V/50Hz	4.2	5	100	114x94x213
NS-9504		4.7		180*	149x153x197



# 夾縫落樸防皺粘合壓平機

Seam Fusing Machine

## NS-8933

自動雙頭粘合機  
Automatic Double  
Buck Fusing Press



## NS-8934

自動三頭粘合壓平機  
Automatic Triple-Buck Fusing Machine



NS-8933/NS-8934 壓前幅  
Pressing shirt front

F226  
拉鈕子落樸蝴蝶  
Plait Folder with Interlining

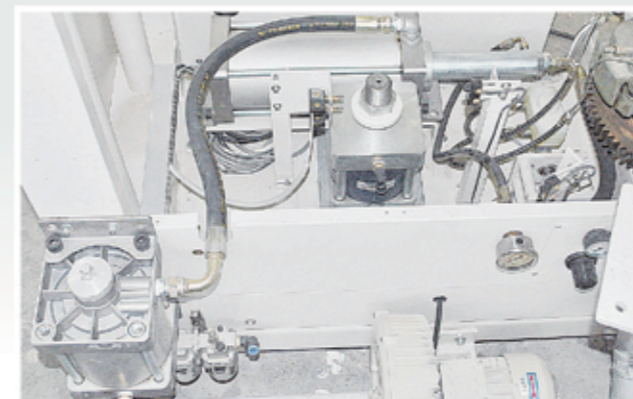
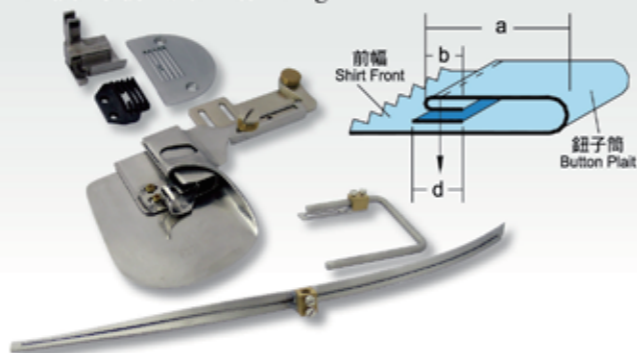

NS-8934/NS-8934-L 增壓系統  
Pressure booster

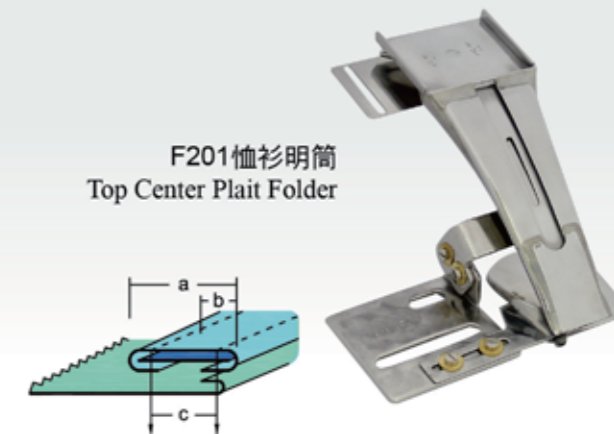

F201 恤衫明筒  
Top Center Plait Folder

型號 Model	電源 Power Supply	總功率(kW) Total Power	工作台面尺寸(mm) Working Table Size	壓縮空氣壓力(kgf/cm <sup>2</sup> ) Compressed Air Pressure	平均粘合壓力(kgf/cm <sup>2</sup> ) Average Fusing Pressure	機身尺寸(cm) Machine Size
NS-8933-H	3PH/380V/50Hz	11.5	800x400	5	5	166x196x160
NS-8933-S			1000x320			166x196x160
NS-8933-L			1000x500			166x196x160
NS-8933-XL		18*	1300x700		1.5	166x196x160*
NS-8933-A		11.5	1400x320		2.5	199x234x160

型號 Model	電源 Power Supply	總功率(kW) Total Power	缸徑(mm) Dia. of Cylinder	壓縮空氣壓力(kgf/cm <sup>2</sup> ) Compressed Air Pressure	平均粘合壓力(kgf/cm <sup>2</sup> ) Average Fusing Pressure	台面尺寸(mm) Size of Working Table	機身尺寸(cm) Machine Size
NS-8934	3PH/380/50Hz	11.5	Ø160	5	5	800x400	217x202x155
NS-8934-L			Ø200			1000x500	262x237x162



# 夾縫落樸防皺粘合壓平機

Seam Fusing Machine

## NS-9205

自動前筒粘合機  
Automatic Placket  
Fusing Machine

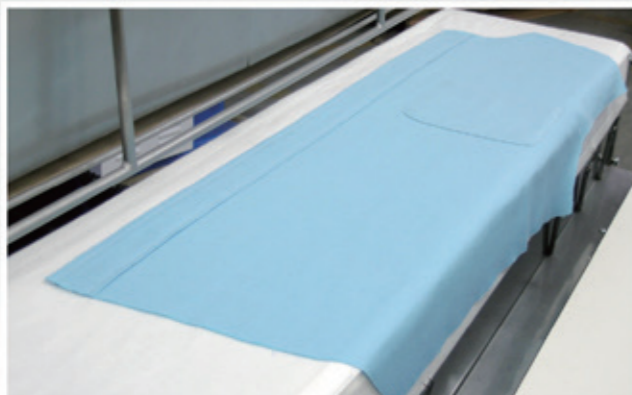
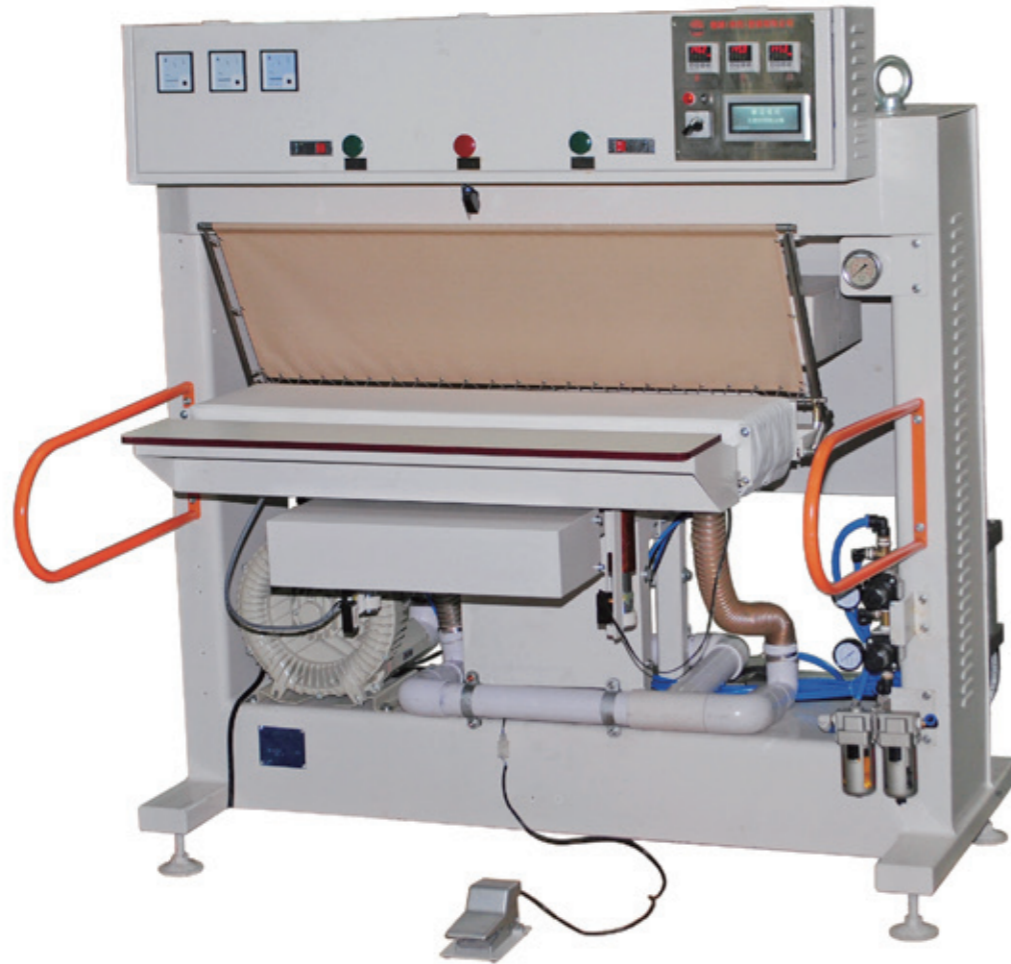

NS-9205 壓熨前筒  
Pressing shirt front placket

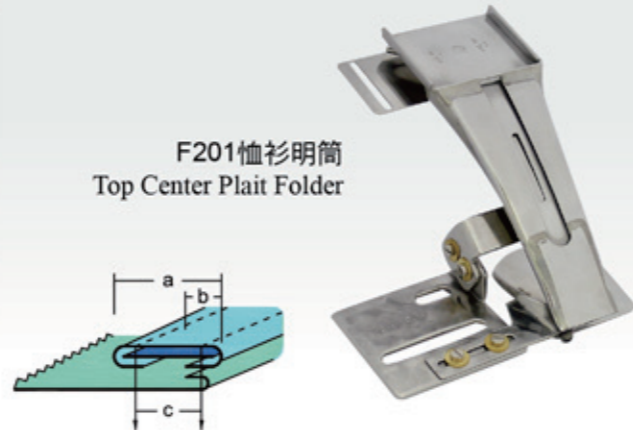

F201 恤衫明筒  
Top Center Plait Folder

型號 Model	電源 Power Supply	總功率(kW) Total Power	下模尺寸(mm) Lower Mould Size	壓縮空氣壓力 (kgf/cm <sup>2</sup> ) Compressed Air Pressure	增壓壓力 (kgf/cm <sup>2</sup> ) Increasing Pressure	平均粘合壓力 (kgf/cm <sup>2</sup> ) Average Fusing Pressure	機身尺寸 (cm) Machine Size
NS-9205	3PH/380V/50Hz	7	1000x254	5	80	5	150x167x160

## A902

上送樸器  
Top Tape Feeder



A902安裝位置圖  
Appearance of A902 after installing to a sewing machine

## A903

側送樸器  
Side Tape Feeder



A903安裝位置圖  
Appearance of A903 after being installed to a sewing machine

## A904

防打結上送樸器  
Top Tape Feeder with  
Un-Twisting Device



A904安裝位置圖  
Appearance of A904 after being installed to a sewing machine



# 藥水沉浸及焗爐設備

## Chemical Dipping & Curing Oven Equipment

### NS-395

運輸帶式焗爐  
Conveyor Belt Type Curing Oven



自動收料系統(選購件)  
Automatic garment unloading system(Optional)

### NS-399

運帶式焗爐  
Conveyor Belt Oven



NS-395G  
最適用於焗褲子  
It is best for trousers curing



自動收料系統 (選購件)  
Automatic garment unloading system(Optional)



選購件 Option:  
預熱系統(蒸汽熱型)  
Preheating system  
(Steam heated type)

型號 Model	加熱方式 Heating Mode	加熱區鏈長度(m) Length of Heating Area	電源 Power Supply	總功率 (kW) Total Power	最高溫度 (°C) Max. Temp.	最大掛件長度 (mm) Max. Garment Hanging Height	最小掛距(mm) Min. Distance between Each Piece	可設定烘干時間 (min) Adjustable Drying Time	機身尺寸(cm) Machine Size
NS-395E-30	電 electric	3.4*	3PH/380V/50Hz	56*	200	1200	37.5	3' 20"~30'	600x280x342
NS-395E-50		5.1		119					915x280x342
NS-395E-80		8.5		1255x280x342					
NS-395G-50	瓦斯 gas	5.1		11.1					915x271x335
NS-395G-80		8.5		11.1					1255x271x335
NS-395G-120		11.9		15					1605x271x335



適用於焗襯衣或褲子  
It is best for shirts and trousers curing



操作中  
In working



選購件 Option:  
蒸汽加熱 Steam heating

型號 Model	加熱方式 Heating Mode	加熱區鏈長度(m) Chain Length in the Heating Area	電源 Power Supply	總功率 (kW) Total Power	最高溫度 (°C) Max. Temp.	最大掛件(mm) Max. Garment Size	最小掛距(mm) Min. Distance between Each Piece	可設定烘干時間 (min) Adjustable Drying Time	機身尺寸(cm) Machine Size
NS-399E-50	電 electric	5	3PH/380V/50Hz	75	200	800x1200	37.5	3' 20"~30'	878x316x312
NS-399G-50	瓦斯 gas			22.5					878x316x312



# 藥水沉浸及焗爐設備

Chemical Dipping & Curing Oven Equipment

## NS-392E-36

櫃式焗爐 - 電熱  
Batch Curing Oven - Electric

## NS-392G-72

櫃式焗爐 - 天然氣  
Batch Curing Oven - Gas



NS-392E-8  
櫃式焗爐  
Batch Curing Oven

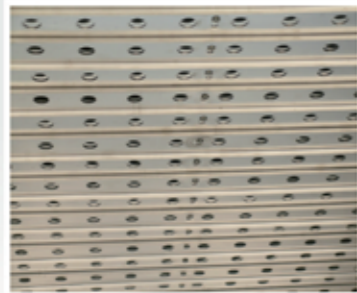

氣流量可調節以保持溫度平衡  
The air flowing rate can be adjusted to keep even temperature



高質、耐用燃燒機(G系列用)  
With high-quality, durable burner (for G series)

加熱方式：  
Heating Mode:

- E- 電熱型  
Electric heat
- G- 瓦斯熱型  
LPG heat
- G- 天然氣熱型  
Natural Gas heat

型號 Model	電源 Power Supply	總功率(KW) Total Power	最高溫度(°C) Max. Temp.	石油氣耗量 LPG Consumption (kg/hr)	天然氣耗氣量 Natural Gas Consumption(m³/h)	爐腔尺寸(cm) Inner chamber
NS-392E-8	3PH/380V/50Hz	16.5	200	---	---	75x95x168
NS-392E-36		41.5				148x148x168
NS-392E-72		79.5		198x198x168		
NS-392G-36		6.5		7.4	9.5	148x148x168
NS-392G-72		10.5		14.8	19	198x198x168

## SH-101

木衣架  
Wooden Hanger



## SH-102

木衣架  
Wooden Hanger



## SH-104

不銹鋼衣架  
Stainless Steel Hanger



## TH-201

不銹鋼褲夾  
Stainless Steel Trouser Hanger



## TH-101

木褲夾  
Wooden Trouser Hanger



衣架類型 Type of hangers	TH-101	TH-201	SH-101	SH-102	SH-104
尺寸(mm) Size(LxWxH)	280x22x175	302x30x154	430 x 45 x 255	530 x 43 x 245	470 x 55 x 250

## GT-36-SS

焗爐車仔  
Oven trolley



## GT-72-SS

焗爐車仔  
Oven trolley



型號 Model	規格(inch) Specification	最大掛件數量(pcs) Max. Hanging Qty	適用型號 Suitable for
GT-36-SS	36	36	NS-392E-36 / NS-392G-36
GT-72-SS	72	144	NS-392E-72 / NS-392G-72



### NS-2452-3

自動定量噴藥機  
Automatic Preset Chemical  
Spraying Machine



機身可傾斜倒料  
Tiltable machine body For  
garment unloading



自動入藥水缸  
Automatic chemical dosing tank

型號 Model	內膽容積(m <sup>3</sup> ) Inner Drum Capacity	電源 Power supply	馬達功率(kW) Motor Power	內膽尺寸(mm) Inner Drum Size	壓縮空氣壓力(kgf/cm <sup>2</sup> ) Compressed Air Pressure	耗壓縮空氣量(L/min) Compressed Air Consumption	機身尺寸(cm) Machine Size
NS-2452-3	3	3PH/380V/50Hz	2.5	Ø1782x1200	5	180	250x225x288

### NS-2422

自動定量噴藥機  
Automatic Preset Chemical Spraying Machine



NS-2422-300  
控制面板  
Control Panel

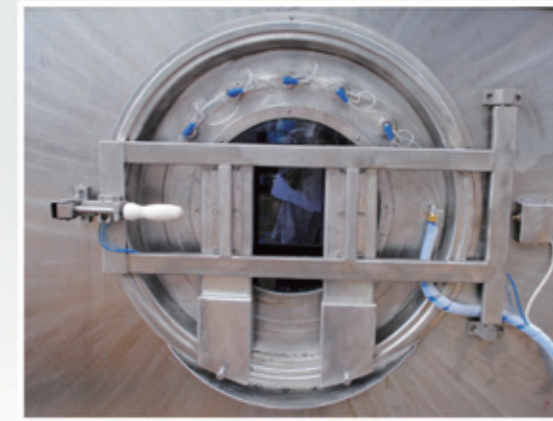

NS-2422-300  
五組噴嘴，使噴藥更加均勻  
Five groups of nozzles applied for  
more even chemical spraying

型號 Model	容量(lbs) Capacity	電源 Power Supply	總功率(kW) Total Power	內膽尺寸(mm) Inner Drum Size	壓縮空氣壓力 (kgf/cm <sup>2</sup> ) Compressed Air Pressure	耗壓縮空氣量(L/min) Compressed Air Consumption	機身尺寸(cm) Machine Size
NS-2421-30	30	1PH/220V/50Hz	0.9	Ø788x534	5	130	138x113x162
NS-2422-300	300	3PH/380V/50Hz	4.2	Ø1778x1040		180	242x197x224



# 襯衫防皺整熨設備

Shirt Finishing Equipment

## 男裝襯衫防皺整熨 Wrinkle-free Pressing of Men's Shirt

序號 No.	1.預燙 Pre-pressing	2.領圈 Collar	3.擔桿 Yoke	4.側縫 Side Seam	5.雙袖 Double sleeves
壓燙部位 Pressing Part					
壓燙模型 Pressing Model					
NS-81XX 	NS-3541 & NS-3602B	—	NS-8166 (可換模) (Replaceable mould)	NS-8167	NS-8155AD
NS-82XX 		—	—	—	—
NS-84XX 		—	—	—	—
NS-84XX 		NS-8435 (可換模) (Replaceable mould)	—	NS-8402P	NS-8408-L NS-8408-R
NS-89XX 		—	NS-8966	—	NS-8955M
NS-92XX 		—	—	—	NS-9255
NS-94XX 		—	NS-9401	—	—
NS-96XX 		—	—	NS-9666 (可換模) (Replaceable mould)	—

## 男裝襯衫防皺整熨 Wrinkle-free Pressing of Men's Shirt

6.側袖筒 Side sleeve placket	7.後幅 Back	8.左右前幅 Right and left front	9.領&袖口 Collar & Cuff	10.執燙 Ironing	11.焗爐 Curing Oven
NS-8161	NS-8160	NS-8164 & NS-8165	NS-8143M	NS-3531 & NS-3602B	NS-392 / NS-395
—	—	—	NS-8243MP		
NS-8411 (雙模獨立操作) (Double moulds independent operation)	—	—	—		
NS-8403P	—	—	NS-8443M		
—	NS-8960	NS-8962 (可換模) (Replaceable mould)	—		
—	NS-9259 (可換模)	NS-9264 NS-9265 (可換模) (Replaceable mould)	—		
—	—	—	—		
—	NS-9660 (可換模) (Replaceable mould)	NS-9664 NS-9665 (可換模) (Replaceable mould)	—		





### NS-8435

擔桿領圍壓平機  
Yoke Neck Press



### NS-8166

電加熱式襯衫萬能擔桿壓平機  
Electric Heated Utility Shirt Yoke Press



### NS-9666

自動襯衫擔桿壓平機  
Automatic Shirt Yoke Press



### NS-8167

電加熱式男裝側縫壓平機  
Electric Heated Man Shirt Side Seam Press



### NS-8966

自動轉頭擔桿壓平機  
Automatic Rotation Yoke Press



### NS-9401

自動雙擔桿壓平機  
Automatic Double Yoke Pressing Machine



### NS-8402P

自動袖衫側縫壓平機  
Automatic Sleeve Side Seam Press



### NS-8155AD

電加熱式男裝雙袖壓平機  
Electric Heated Man Shirt Double Sleeve Press



型號 Model	電源 Power Supply	總功率(kW) Total Power	壓縮空氣壓力(kgf/cm <sup>2</sup> ) Compressed Air Pressure	耗壓縮空氣量(L/min) Compressed Air Consumption	機身尺寸(cm) Machine Size
NS-8166	3PH/380V/50Hz	2.5	5	150	160x155x200
NS-8435		3.5		100	105x85x220
NS-8966		6.2		120	179x166x171
NS-9401		4.9		100	159x108x217

型號 Model	電源 Power Supply	總功率(kW) Total Power	壓縮空氣壓力(kgf/cm <sup>2</sup> ) Compressed Air Pressure	耗壓縮空氣量(L/min) Compressed Air Consumption	機身尺寸(cm) Machine Size
NS-8155AD	3PH/380V/50Hz	5	5	150	194x156x200
NS-8167		5.6			158x155x200
NS-8402P		6.3		120	151x95x215
NS-9666		6.2		150	312x133x169



### NS-8408L / NS-8408R

自動襯衫袖壓平機-左/右  
Automatic Shirt Sleeve Press - Left / Right

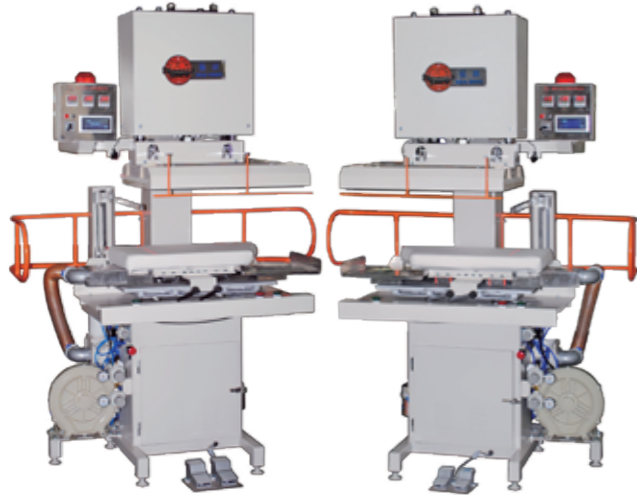

### NS-8955M

自動轉頭雙袖壓平機  
Automatic Rotation Double Sleeve Press



### NS-8411

雙頭袖褶壓平機  
Double Head Sleeve Pleat Pressing Machine



### NS-8403P

雙頭側袖筒壓平機  
Sleeve Placket Press-Double Head



### NS-9255

自動雙袖壓平機  
Automatic Double Sleeve Pressing Machine



### NS-8161

雙頭袖褶壓平機  
Double Head Sleeve Pleat Pressing Machine



### NS-8160

電加熱式衫身壓平機  
Electric Heated Shirt Body Press



### NS-8960

自動轉頭電加熱式襯衫後幅壓平機  
Automatic Rotation Electric Heated Shirt Back Press



型號 Model	電源 Power Supply	總功率(kW) Total Power	壓縮空氣壓力(kgf/cm <sup>2</sup> ) Compressed Air Pressure	耗壓縮空氣量(L/min) Compressed Air Consumption	機身尺寸(cm) Machine Size
NS-8161	3PH/380V/50Hz	2.5	5	120	136x114x169
NS-8408L/NS-8408R		6.5		140	109x74x215
NS-8955M		5.6		120	193x168x150
NS-9255		5		150	200x177x167

型號 Model	電源 Power Supply	總功率(kW) Total Power	壓縮空氣壓力(kgf/cm <sup>2</sup> ) Compressed Air Pressure	耗壓縮空氣量(L/min) Compressed Air Consumption	機身尺寸(cm) Machine Size
NS-8160	3PH/380V/50Hz	7.4	5	150	160x160x200
NS-8403P		4.2		100	106x93x215
NS-8411		3.1		100	130x95x215
NS-8960		11.8		80	200x179x190



### NS-9259

男裝襯衫后幅壓平機  
Man Shirt Back Press



### NS-9660

自動襯衫後幅壓平機  
Automatic Shirt Back Press



### NS-9265 / NS-9264

男裝襯衫左/右前幅壓平機  
Man Shirt Front Left / Right Press



### NS-9665/9664

自動襯衫左/右前幅壓平機  
Automatic Shirt Front Left / Right Press



### NS-8164 / NS-8165

男裝襯衫左 / 右前幅壓平機  
Man Shirt Front Right Press



### NS-8962

自動轉頭電加熱式男裝衫前幅左/右壓平機  
Automatic Rotation Buck Electric Heated  
Man Shirt Front Left / Right Press



### NS-8143M

電加熱式男裝領袖壓平機  
Electric Heated Man Shirt Collar and Cuff Press



### NS-8243MP

自動領袖壓平機(男裝)  
Automatic Collar and Cuff



型號 Model	電源 Power Supply	總功率(kW) Total Power	壓縮空氣壓力(kgf/cm <sup>2</sup> ) Compressed Air Pressure	耗壓縮空氣量(L/min) Compressed Air Consumption	機身尺寸(cm) Machine Size
NS-8164/NS-8165	3PH/380V/50Hz	9.2	5	150	158x157x200
NS-8962		6.2			181x208x161
NS-9259		17			145x277x181
NS-9660		32.6			382x205x169

型號 Model	電源 Power Supply	總功率(kW) Total Power	壓縮空氣壓力(kgf/cm <sup>2</sup> ) Compressed Air Pressure	耗壓縮空氣量(L/min) Compressed Air Consumption	機身尺寸(cm) Machine Size
NS-8143M	3PH/380V/50Hz	5	5	150	156x156x200
NS-8243MP					142x127x152
NS-9264/NS-9265		6.1			142x164x164
NS-9664/NS-9665		8			392x154x169



# 襯衫防皺整熨設備

Shirt Finishing Equipment

## 女裝襯衫防皺整熨 Wrinkle-free Pressing of Ladies' Shirt

序號 No.	1.預燙 Pre-pressing	2.側縫 Side Seam	3.擔桿 Yoke	4.雙袖 Double sleeves	5.側袖筒 Side sleeve placket
壓燙部位 Pressing Part					
壓燙模型 Pressing Model					
NS-81XX	NS-3541 & NS-3602B	NS-8153	NS-8152 (可換模) (Replaceable mould)	NS-8156AD	NS-8161
NS-82XX		—	—	—	—
NS-84XX		—	—	—	NS-8411 (雙模獨立操作) (Double moulds independent operation)
		—	NS-8435 (可換模) (Replaceable mould)	NS-8408-L NS-8408-R	NS-8403P
NS-89XX		NS-8953	NS-8966 (可換模) (Replaceable mould)	NS-8955F	—
NS-92XX		—	—	NS-9255	—
NS-94XX		—	NS-9401F	—	—
NS-96XX		—	—	NS-9666 (可換模) (Replaceable mould)	—

## 女裝襯衫防皺整熨 Wrinkle-free Pressing of Ladies' Shirt

6.後幅 Back	7.右前幅 Right front	8.左前幅 Left front	9.領&袖口 Collar & Cuff	10.執燙 Ironing	11.焗爐 Curing Oven
NS-8106	NA-8104	NS-8105	NS-8143F	NS-3531 & NS-3602B	NS-392 / NS-395
—	—	—	NS-8243FP		
—	—	—	—		
—	—	—	NS-8443F		
NS-8906	NS-8964F	NS-8965F	—		
—	NS-9264F (可換模) (Replaceable mould)	NS-9265F (可換模) (Replaceable mould)	—		
—	—	—	—		
NS-9660 (可換模) (Replaceable mould)	NS-9664 (可換模) (Replaceable mould)	NS-9665 (可換模) (Replaceable mould)	—		



### NS-8153

電加熱式平面側縫壓平機  
Electric Heated Slim Side Seam Press



### NS-8152

電加熱式女裝萬能擔桿壓平機  
Electric Heated Lady Utility Blouse Yoke Press



### NS-9401F

自動女裝雙擔桿壓平機  
Automatic Lady Blouse Double Yoke Press



### NS-9666

自動襯衫擔桿壓平機  
Automatic Shirt Yoke Press



### NS-8435

擔桿領圈壓平機  
Yoke Neck Press



### NS-8966

自動轉頭擔桿壓平機  
Automatic Rotation Yoke Press



### NS-8156AD

電加熱式女裝雙袖壓平機  
Electric Heated Lady Blouse Double Sleeve Press



### NS-8408L / NS-8408R

自動襯衫袖壓平機-左/右  
Automatic Shirt Sleeve Press - Left / Right

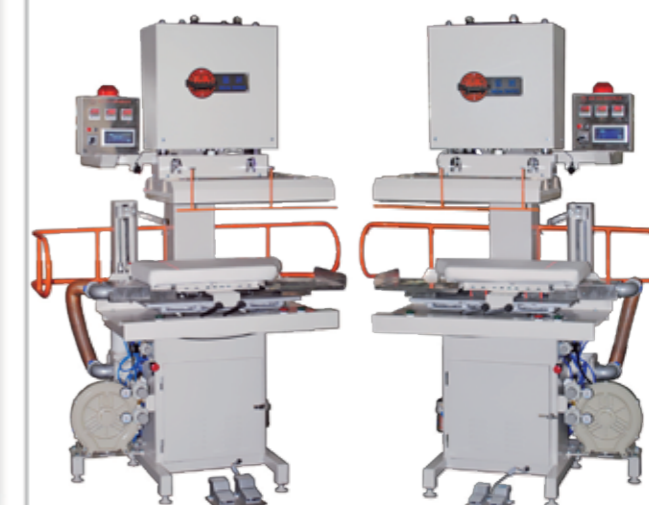

型號 Model	電源 Power Supply	總功率(kW) Total Power	壓縮空氣壓力(kgf/cm <sup>2</sup> ) Compressed Air Pressure	耗壓縮空氣量(L/min) Compressed Air Consumption	機身尺寸(cm) Machine Size
NS-8152	3PH/380V/50Hz	2.6	5	100	158x157x200
NS-8153		2.6		120	158x156x200
NS-8435		3.5		100	105x85x220
NS-8966		6.2		120	179x166x171

型號 Model	電源 Power Supply	總功率(kW) Total Power	壓縮空氣壓力(kgf/cm <sup>2</sup> ) Compressed Air Pressure	耗壓縮空氣量(L/min) Compressed Air Consumption	機身尺寸(cm) Machine Size
NS-8156AD	3PH/380V/50Hz	5	5	150	194x156x200
NS-8408L/NS-8408R		6.5		140	109x74x215
NS-9401F		4.9		100	159x108x217
NS-9666		6.2		150	312x133x168



### NS-8955F

自動轉頭女裝雙袖壓平機  
Automatic Rotation Lady Blouse Double Sleeve Press



### NS-9255

自動雙袖壓平機  
Automatic Double Sleeve Pressing Machine



### NS-8403P

雙頭側袖筒壓平機  
Sleeve Placket Press-Double Head



### NS-8106

電加熱式女裝襯衫後幅壓平機  
Electric Heated Lady Blouse Back Press



### NS-8161

雙頭袖摺壓平機  
Double Head Sleeve Pleat Pressing Machine



### NS-8411

雙頭袖摺壓平機  
Double Head Sleeve Pleat Pressing Machine



### NS-8906

自動轉頭女裝襯衫後幅壓平機  
Automatic Rotation Lady Shirt Back Press



### NS-9660

自動襯衫後幅壓平機  
Automatic Shirt Back Press



型號 Model	電源 Power Supply	總功率(kW) Total Power	壓縮空氣壓力(kgf/cm <sup>2</sup> ) Compressed Air Pressure	耗壓縮空氣量(L/min) Compressed Air Consumption	機身尺寸(cm) Machine Size
NS-8161	3PH/380V/50Hz	2.5	5	120	136x114x169
NS-8411		3.1		100	130x95x215
NS-8955F		5.6		120	193x168x150
NS-9255		5		150	200x177x167

型號 Model	電源 Power Supply	總功率(kW) Total Power	壓縮空氣壓力(kgf/cm <sup>2</sup> ) Compressed Air Pressure	耗壓縮空氣量(L/min) Compressed Air Consumption	機身尺寸(cm) Machine Size
NS-8106	3PH/380V/50Hz	7.5	5	150	158x155x200
NS-8403P		4.2		100	106x93x215
NS-8906		11.8		80	200x179x190
NS-9660		32.6		150	382x205x169



# 襯衫防皺整熨設備

## Shirt Finishing Equipment

### NS-8104

電加熱式女裝襯衫右前幅壓平機  
Electric Heated Lady Blouse Front Right Press



### NS-8105

電加熱式女裝襯衫左前幅壓平機  
Electric Heated Lady Blouse Front Left Press



### NS-9665/9664

自動襯衫左/右前幅壓平機  
Automatic Shirt Front Left / Right Press



### NS-8143F

電加熱式女裝領袖壓平機  
Electric Heated Lady Blouse Collar And Cuff Press

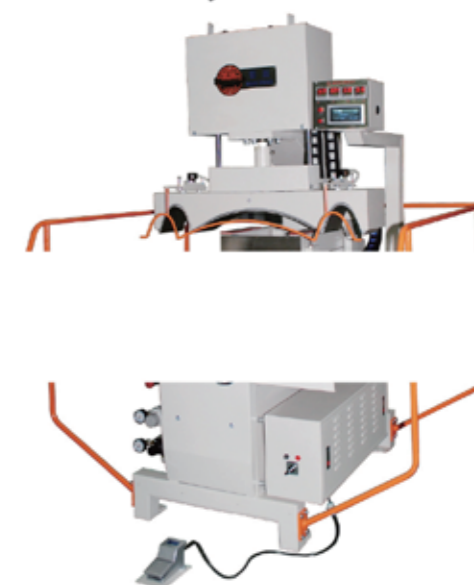

### NS-9264F

女裝襯衫右前幅壓平機  
Lady Shirt Front Right Press



### NS-9265F

女裝襯衫左前幅壓平機  
Lady Shirt Front Left Press



### NS-8243FP

自動領袖壓平機(女裝)  
Automatic Collar & Cuff Press(Lady)



### NS-8443F

自動電加熱式(女裝)領袖壓平機  
Auto. Electric Heated Collar & Cuff Press



型號 Model	電源 Power Supply	總功率(kW) Total Power	壓縮空氣壓力(kgf/cm <sup>2</sup> ) Compressed Air Pressure	耗壓縮空氣量(L/min) Compressed Air Consumption	機身尺寸(cm) Machine Size
NS-8104/NS-8105	3PH/380V/50Hz	6.8	5	150	158x160x200
NS-9264F/NS-9265F		6.1			142x164x164

型號 Model	電源 Power Supply	總功率(kW) Total Power	壓縮空氣壓力(kgf/cm <sup>2</sup> ) Compressed Air Pressure	耗壓縮空氣量(L/min) Compressed Air Consumption	機身尺寸(cm) Machine Size
NS-8143F	3PH/380V/50Hz	5	5	150	156x156x200
NS-8243FP					142x127x152
NS-8443F					133x85x215
NS-9664/NS-9665					392x154x169



# 外衣整熨設備

Coat Ironing Room Equipment



## NS-7214

自動袖籠壓平機  
Automatic Armhole Side Press



## NS-7241

自動雙袖縫壓平機  
Automatic Double Sleeve Seam Press

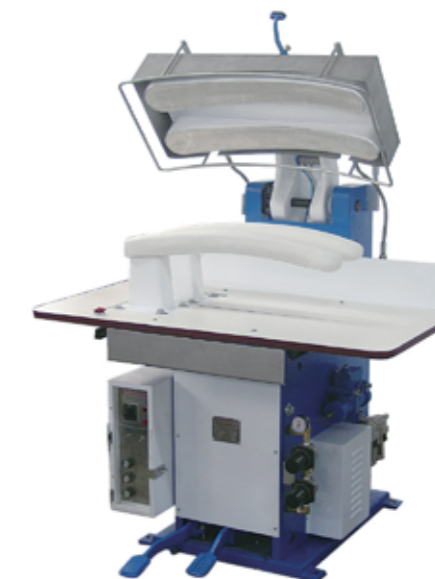

## NS-7201

自動雙肩壓平機  
Automatic Double Shoulder Press



## NS-7207

自動前胸右壓平機  
Automatic Coat Front Right Press



## NS-7221

自動駁頭壓平機  
Automatic Lapel Press



## NS-7237

自動前襟壓平機  
Automatic Collar Master Press

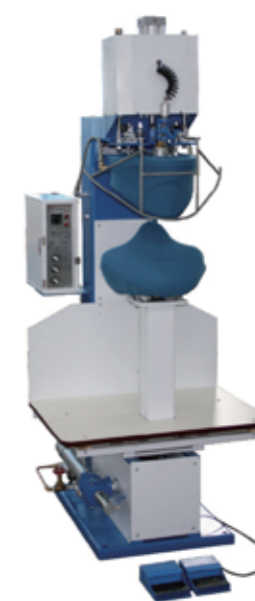

型號 Model	電源 Power Supply	總功率(kW) Total Power	壓縮空氣壓力 Compressed Air Pressure(kg/cm <sup>2</sup> )	耗壓縮空氣量 Compressed Air Consumption(L/min)	耗蒸汽量(kg/hr) Steam Consumption	機身尺寸(cm) Machine Size
NS-7201	1PH/220V/50Hz	0.1	5	80*	10*	95x142x167
NS-7207				150	20*	117x90x146
NS-7208				100	12	89x95x167
NS-7211						

型號 Model	電源 Power Supply	總功率(kW) Total Power	需配真空泵 Required Vacuum Pump(HP)	耗壓縮空氣量 Compressed Air Consumption(L/min)	耗蒸汽量(kg/hr) Steam Consumption	機身尺寸(cm) Machine Size
NS-7214	1PH/220V/50Hz	0.1	1	80	10	89x95x167
NS-7221				100	12	
NS-7237			1.5	80*	15	90x116x215
NS-7241				100		117x103x166





# 風雨衣整熨設備

Rain Coat Ironing Equipment



型號 Model	電源 Power Supply	總功率(kW) Total Power	需配真空泵 Required Vacuum Pump(HP)	耗壓縮空氣量 Compressed Air Consumption(L/min)	耗蒸汽量(kg/hr) Steam Consumption	機身尺寸(cm) Machine Size
NS-7251	1PH/220V/50Hz	0.1	1.5*	100	12*	92x105x165
NS-7252						105x92x165

型號 Model	電源 Power Supply	總功率(kW) Total Power	需配真空泵 Required Vacuum Pump(HP)	耗壓縮空氣量 Compressed Air Consumption(L/min)	耗蒸汽量(kg/hr) Steam Consumption	機身尺寸(cm) Machine Size	
NS-7253	1PH/220V/50Hz	0.1	1.5*	100	12*	92x105x165	
NS-7254						105x92x165	
NS-7255			2	150	20	20	105x143x165
NS-7256							
NS-7257							



### NS-3400

真空抽濕泵連氣水分離罐  
Vacuum Pump with Air Container



真空抽濕泵  
Vacuum Pump



氣水分離器  
Steam water separator

### NS-3400安裝方法 Installation Method of NS-3400

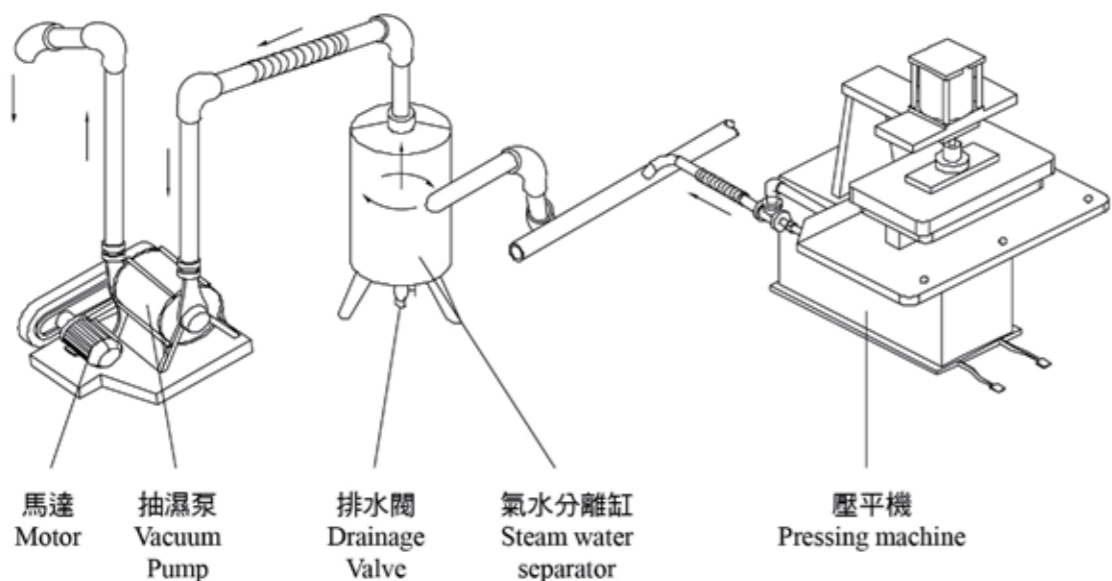

### NS-3403

真空泵連水箱  
Vacuum Pump with Tank



### NS-3402-3

鼓風機  
Blower

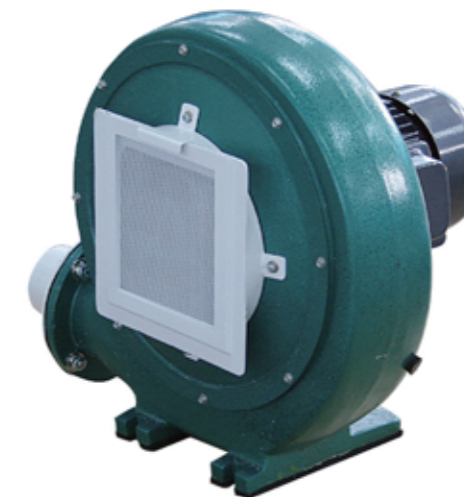

### NS-3401

抽風泵  
Vacuum Pump



NS-3401適用於壓平機上抽濕以幫助定位  
Installed on pressing machine to vacuum and hold fabric in position.

型號 Model	電源 Power Supply	配用電機 (HP) Motor	最大風量 Q(m <sup>3</sup> /min) Max. Volume of Air	最高靜壓 P(mm) 汞柱 Pressure	吸氣口徑(mm) Dia. of Inlet	排氣口徑 Dia. of Vent	泵噪聲(dB) Pump Noise	重量 Weight
NS-3400-7.5	3PH/380V/50Hz	7.5	15	-75	125	130	≤73	540
NS-3400-10		10		-103				600
NS-3400-15		15		-143				640
NS-3400-20		20	22	-210				555
NS-3400-25		25		-280				670
NS-3400-30		30		-315				750

型號 Model	電源 Power supply	總功率(HP) Total Power	轉速(rpm) Speed	最大軸氣量(m <sup>3</sup> /min) Max. Axial Flowrate	最大吸力(mmHg) Max. Sucking Power	吸氣口徑(mm) Dia. of Inlet	排氣口徑(mm) Dia. of Vent
NS-3401-1.5	1PH/220V/50Hz	1.5	-	-	-	-	-
NS-3401-3	3PH/380V/50Hz	3					
NS-3401-4		4					
NS-3402-3		3					
NS-3403-3		5	5	2900	15	50	100
NS-3403-5	75					100	

# 索引 Index

序號	產品編號	中文精簡說明	英文精簡說明	頁數
001	A902	上送模器	Top Tape Feeder	133
002	A903	側送模器	Side Tape Feeder	133
003	A904	防打結上送模器	Top Tape Feeder with Un-Twisting Device	133
004	GT-36-SS	焗爐車仔 - 不銹鋼	Denim Inspecting & Loosening Machine	137
005	GT-72-SS	焗爐車仔 - 不銹鋼	Denim Inspecting & Loosening Machine	137
006	NS-41	四邊折袋蓋機	Pocket Flap Creasing Machine	041
007	NS-41-L	四邊折袋蓋機	Pocket Flap Creasing Machine	041
008	NS-42	反領針機	Turn Collar Needle Machine	030
009	NS-43	折袋機	Pocket Creasing Machine	041
010	NS-43-L	折袋機	Pocket Creasing Machine	041
011	NS-44	反領機	Collar Turning And Blocking Machine	031
012	NS-45	電動釘鈕機	Electric Snap Fixing Machine	084
013	NS-46	袖口機	Cuff Turning And Blocking Machine	039
014	NS-47	氣動釘鈕機-連十字定位燈及安全罩	Pneumatic Snap Fixing Machine With Light Marker	084
015	NS-47U	氣動釘鈕機-連十字定位燈及安全罩	Pneumatic Snap Fixing Machine With Light Marker	084
016	NS-50	折衫台	Shirt Folding Table	079
017	NS-50-S	折衫台	Shirt Folding Table	078
018	NS-52	拉布機(不連Z路軌)	Expandable Cloth Spreader (Without 60ft L Track)	011
019	NS-53P	自動反領焗領機	Automatic Retractable Collar Turning And Blocking Machine	032
020	NS-54	吸線頭機 - 無電眼感應	Thread Cleaning Machine (Economic Model)	071
021	NS-55	吸線頭機 - 連電眼感應	Thread Cleaning Machine With Electric Eye Sensor	070
022	NS-56	松布機	Fabric Loosening Machine	019
023	NS-57	切布機(縱直紋)	Fabric Cutting Machine (Straight And Bias Cutting)	011
024	NS-58H-72	自動對邊卷布驗布機	Cloth Winding Inspection M/c With Edge Control Device	012
025	NS-58H-84	自動對邊卷布驗布機	Cloth Winding Inspection M/c With Edge Control Device	012
026	NS-58H-96	自動對邊卷布驗布機	Cloth Winding Inspection M/c With Edge Control Device	012
027	NS-58L-72	自動對邊卷布驗布機	Cloth Winding Inspection M/c With Edge Control Device	012
028	NS-58L-84	自動對邊卷布驗布機	Cloth Winding Inspection M/c With Edge Control Device	012
029	NS-58L-96	自動對邊卷布驗布機	Cloth Winding Inspection M/c With Edge Control Device	012
030	NS-59H-72	卷布驗布機	Cloth Winding Inspection Machine	013
031	NS-59H-84	卷布驗布機	Cloth Winding Inspection Machine	013
032	NS-59H-96	卷布驗布機	Cloth Winding Inspection Machine	013
033	NS-59L-72	卷布驗布機	Cloth Winding Inspection Machine	013
034	NS-59L-84	卷布驗布機	Cloth Winding Inspection Machine	013
035	NS-59L-96	卷布驗布機	Cloth Winding Inspection Machine	013
036	NS-63-72	牛仔布驗布、松布機	Denim Inspecting & Loosening Machine	019
037	NS-69	切布機(短柄-推) 全台	End Cutter (Short Handle-Push) Complete Set	011
038	NS-70	切布機(長柄-推) 全台	End Cutter (Long Handle-Push) Complete Set	011
039	NS-75	切領咀機	Collar Point Trimming Machine	030
040	NS-76A	領咀反領機	Collar Point Trimming And Turning Machine	030
041	NS-76B	切領咀反領機	Collar Point Trimming And Turning Machine	030
042	NS-80	熨領角機	Collar Pressing Machine	031
043	NS-81P	自動切領咀反領焗領機	Automatic Collar Trimming, Turning And Blocking Machine	033
044	NS-82P	自動焗領機	Automatic Collar Blocking Machine	034
045	NS-85LP	自動焗袖口機	Automatic Cuff Blocking Machine	038
046	NS-85P	自動焗袖口機	Automatic Cuff Blocking Machine	039
047	NS-87P	自動切領咀反領焗領機 連左右機械手	Automatic Collar Trimming, Turning and Blocking Machine with Left & Right Automatic Arm	034

序號	產品編號	中文精簡說明	英文精簡說明	頁數
048	NS-88P	自動切領咀反領焗領機 連左右機械手及左收料架	Automatic Collar Trimming, Turning and Blocking Machine with Right & Left Automati Arm and Left Stacker	035
049	NS-89P	自動切領咀反領焗領機	Automatic Collar Trimming, Turning And Blocking Machine	032
050	NS-92H	修領腳機	Collar Contour Trimmer	042
051	NS-92L	修領腳機	Collar Contour Trimmer	042
052	NS-93-1	點模機	Spot Welding Machine	022
053	NS-94-1	修筒車	Placket Cutting Machine	043
054	NS-94AC-1	自動收料修筒車	Placket Cutting Machine With Automatic Stacker	043
055	NS-94AC-W	自動收料修筒車	Placket Cutting Machine With Automatic Stacker	043
056	NS-94-W	修筒車	Placket Cutting Machine	043
057	NS-95	氣動點領機	Pneumatic Collar Notcher	036
058	NS-95A	氣動點領機	Pneumatic Collar Notcher	036
059	NS-96	領彎邊打扼機	Collar Curve Edge Notcher	036
060	NS-96A	領彎邊打扼機	Collar Curve Edge Notcher	036
061	NS-100-1	領咀鈕朴打孔送模器	Collar Down Button Lining Feeding Punching Device	037
062	NS-101	縫紉夾鑷坑機	Stitch Profile Clamp Milling Machine	049
063	NS-158	自動對邊夾棉卷驗機	Poly Felt Inspection & Winding Machine With Edge	020
064	NS-200A/NS-300	運輸帶系統	Conveyor System	074
065	NS-333	褲頭熨台	Trouser Topper Ironing Table	089
066	NS-342-3.5-1	小型蒸汽鍋爐	Electric Steam Boiler	065
067	NS-342-3.5-3	小型蒸汽鍋爐	Electric Steam Boiler	065
068	NS-342-4.5-3	小型蒸汽鍋爐	Electric Steam Boiler	065
069	NS-342-5.5-3	小型蒸汽鍋爐	Electric Steam Boiler	065
070	NS-355A	噴蒸汽抽濕熨台	Steam Spray Vacuuming Ironing Table	072
071	NS-385	熨褲骨機	Trousers Seam Ironing Table	089
072	NS-385D	熨褲骨機 - 雙臂	Trousers Seam Ironing Table - Double Buck	089
073	NS-392E-36	櫃式焗爐 - 電熱	Batch Curing Oven - Electric	136
074	NS-392E-72	櫃式焗爐 - 電熱	Batch Curing Oven - Electric	136
075	NS-392E-8	櫃式焗爐 - 電熱	Batch Curing Oven - Electric	136
076	NS-392G-36	櫃式焗爐 - 天然氣	Batch Curing Oven - Gas	136
077	NS-392G-72	櫃式焗爐 - 天然氣	Batch Curing Oven - Gas	136
078	NS-395E-30	運輸帶式焗爐 - 電熱	Conveyer Belt Type Curing Oven - Electric	134
079	NS-395E-50	運輸帶式焗爐 - 電熱	Conveyer Belt Type Curing Oven - Electric	134
080	NS-395E-80	運輸帶式焗爐 - 電熱	Conveyer Belt Type Curing Oven - Electric	134
081	NS-395G-120	運輸帶式焗爐 - 石油氣	Conveyer Belt Type Curing Oven - Gas	134
082	NS-395G-50	運輸帶式焗爐 - 石油氣	Conveyer Belt Type Curing Oven - Gas	134
083	NS-395G-80	運輸帶式焗爐 - 石油氣	Conveyer Belt Type Curing Oven - Gas	134
084	NS-398	蒸汽松布定型機	Steam Fabric Loosing Fixing Machine	020
085	NS-399E-50	運帶式焗爐 - 電熱	Conveyer Belt Oven - Electric	135
086	NS-399G-50	運帶式焗爐 - 天然氣	Conveyer Belt Oven - Gas	135
087	NS-400	架空螺絲轉輸送帶	Upper Spiral Conveyor	075
088	NS-501-54	自動拉布機(不連電槽/路軌)	Automatic Cloth Spreader	021
089	NS-501-66	自動拉布機(不連電槽/路軌)	Automatic Cloth Spreader	021
090	NS-501-72	自動拉布機(不連電槽/路軌)	Automatic Cloth Spreader	021
091	NS-501-84	自動拉布機(不連電槽/路軌)	Automatic Cloth Spreader	021
092	NS-502-54	手動拉布機連切布器	Manual Cloth Spreader With End Cutter	021
093	NS-502-66	手動拉布機連切布器	Manual Cloth Spreader With End Cutter	021
094	NS-502-72	手動拉布機連切布器	Manual Cloth Spreader With End Cutter	021

# 索引 Index

序號	產品編號	中文精簡說明	英文精簡說明	頁數
095	NS-502-84	手動拉布機連切布器	Manual Cloth Spreader With End Cutter	021
096	NS-521	輕型組合式裁床	Light Duty Flexible Cutting Table	004
097	NS-521-A	輕型氣墊式組合式裁床	Floatation Light Duty Flexible Cutting Table	005
098	NS-521-B	輕型抽風式組合式裁床	Vacuum Light Duty Flexible Cutting Table	005
099	NS-522	輕型防火板面組合式裁床	Light Duty Laminated Flexible Cutting Table	004
100	NS-522-A	輕型氣墊式防火板面組合式裁床	Floatation Light Duty Laminated Flexible Cutting Table	005
101	NS-522-B	輕型抽風式防火板面組合式裁床	Vacuum Light Duty Laminated Flexible Cutting Table	005
102	NS-523	重型組合式裁床	Heavy Duty Flexible Cutting Table	004
103	NS-523-A	重型氣墊式組合式裁床	Flotation Heavy Duty Flexible Cutting Table	005
104	NS-523-B	重型抽風式組合式裁床	Vacuum Heavy Duty Flexible Cutting Table	005
105	NS-524	重型防火板面組合式裁床	Heavy Duty Laminated Flexible Cutting Table	004
106	NS-524-A	重型氣墊式防火板面組合式裁床	Floatation Heavy Duty Laminated Flexible Cutting Table	005
107	NS-524-B	重型抽風式防火板面組合式裁床	Vacuum Heavy Duty Laminated Flexible Cutting Table	005
108	NS-532	針織驗布機連松布撥	Knitting Fabric Inspection M/c With Loosing Spreader	019
109	NS-601	針床連燈架	Pinning Table With Light Stand	007
110	NS-601-1	針床連燈架	Pinning Table With Light Stand	007
111	NS-630	裁件定位燈座連三支定位燈	Marking Table With Three Light Marker	007
112	NS-650U	氣動折衫台連物料架和放針架	Pneumatic Shirt Folding Table With Material & Pin Stand	076
113	NS-650U-S	氣動折衫台	Pneumatic Shirt Folding Table	078
114	NS-651-S	氣動折衫台	Pneumatic Shirt Folding Table	078
115	NS-651	氣動折衫台	Pneumatic Shirt Folding Table	077
116	NS-710	反褲機	Reversing Trousers Machine	088
117	NS-715	卷褲頭機	Waist Band Winding Machine	086
118	NS-716	自動西褲褲頭車架連6位摺條送料架	Auto Classic Waist Band Sewing Stand	086
119	NS-717	手動松摺條架	Manual Ribbon Loosening Stand	086
120	NS-717-1	自動松摺條架	Auto Ribbon Loosening Stand	086
121	NS-720	反褲袋機	Trousers Pocket Reversing Machine	088
122	NS-810-700	氣墊運剪刀床	Bandknife Cutting Machine With Air Float Table	014
123	NS-810-900	氣墊運剪刀床	Bandknife Cutting Machine With Air Float Table	014
124	NS-850-30L	油壓平面裁斷機	Hydraulic Plane Cutting Press	018
125	NS-850-30S	油壓平面裁斷機	Hydraulic Plane Cutting Press	018
126	NS-850-50L	油壓平面裁斷機	Hydraulic Plane Cutting Press	018
127	NS-850-50S	油壓平面裁斷機	Hydraulic Plane Cutting Press	018
128	NS-860-25-1	搖臂式油壓裁斷機	Hydraulic Swing Arm Cutting Machine	018
129	NS-870-30	龍門式油壓裁斷機	Travel Machine(W/o Sewing M/c Head)	018
130	NS-1110	駁布開骨機(不連衣車頭)	Cloth Joining And Seam Opening Machine (W/o Sewing M/c Head)	015
131	NS-1121-72	自動對邊縱直紋卷布機	Bias And Vertical Cloth Winding M/c With Edge Control	016
132	NS-1121-90	自動對邊縱直紋卷布機	Bias And Vertical Cloth Winding M/c With Edge Control	016
133	NS-1122-72	縱直紋卷布機	Bias And Vertical Cloth Winding Machine	016
134	NS-1122-90	縱直紋卷布機	Bias And Vertical Cloth Winding Machine	016
135	NS-1130S-72	切摺條機連磨刀機	Ribbon Cutting Machine With Sharpening Device	017
136	NS-1130S-90	切摺條機連磨刀機	Ribbon Cutting Machine With Sharpening Device	017
137	NS-1132-72	數控半自動切摺條機連磨刀機	Digital Control Semi-Automatic Ribbon Cutting Machine	017
138	NS-1132-90	數控半自動切摺條機連磨刀機	Digital Control Semi-Automatic Ribbon Cutting Machine	017
139	NS-1150	針織切摺條機	Knit Fabric Cutting Machine	015
140	NS-2261P-450	工業自動洗衣機	Automatic Industrial Washing Machine	113
141	NS-2261P-500	工業自動洗衣機	Automatic Industrial Washing Machine	113
142	NS-2261P-650	工業自動洗衣機	Automatic Industrial Washing Machine	113

序號	產品編號	中文精簡說明	英文精簡說明	頁數
143	NS-2270-160	自動洗衣脫水機	Automatic Washing Extractor	107
144	NS-2270-30	自動洗衣脫水機	Automatic Washing Extractor	107
145	NS-2270-50	自動洗衣脫水機	Automatic Washing Extractor	107
146	NS-2270-80	自動洗衣脫水機	Automatic Washing Extractor	107
147	NS-2272-360-H	自動洗衣機	Automatic Washing Machine	109
148	NS-2272-360-T	自動洗衣機	Automatic Washing Machine	109
149	NS-2272-550-H	自動洗衣機	Automatic Washing Machine	109
150	NS-2272-550-T	自動洗衣機	Automatic Washing Machine	109
151	NS-2273-80	毛衫洗衣脫水機	Sweater Washing Extractor	114
152	NS-2275-160	自動洗衣染色機	Automatic Washing & Dyeing Machine	112
153	NS-2275-5	自動洗衣染色機	Automatic Washing & Dyeing Machine	112
154	NS-2410	輾熨機	Rotary Pressing Machine	047
155	NS-2411	輾熨機	Rotary Pressing Machine	047
156	NS-2421-30	自動定量噴藥機	Automatic Preset Chemical Spraying Machine	139
157	NS-2422-300	自動定量噴藥機連清潔功能	Automatic Preset Chemical Spraying Machine	139
158	NS-2452-3	自動定量噴藥機	Automatic Preset Chemical Spraying Machine	138
159	NS-2500-130	工業脫水機連電子變速及時間剎車	Industrial Extractor	115
160	NS-2500-200	工業脫水機連電子變速及時間剎車	Industrial Extractor	115
161	NS-2500-260	工業脫水機連電子變速及時間剎車	Industrial Extractor	115
162	NS-2500-55	工業脫水機連電子變速及時間剎車	Industrial Extractor	115
163	NS-2610	粘合機	Fusing Machine	023
164	NS-2630	分石機	Stone Separator	122
165	NS-2700-450	工業洗衣機	Industrial Washing Machine	111
166	NS-2700-500	工業洗衣機	Industrial Washing Machine	111
167	NS-2700-650	工業洗衣機	Industrial Washing Machine	111
168	NS-2701-450	工業洗衣機	Industrial Washing Machine	111
169	NS-2701-500	工業洗衣機	Industrial Washing Machine	111
170	NS-2701-650	工業洗衣機	Industrial Washing Machine	111
171	NS-2712-20	工業洗衣機	Industrial Washing Machine	110
172	NS-2712-30	工業洗衣機	Industrial Washing Machine	110
173	NS-2712-50	工業洗衣機	Industrial Washing Machine	110
174	NS-2713-20	工業洗衣機	Industrial Washing Machine	110
175	NS-2713-30	工業洗衣機	Industrial Washing Machine	110
176	NS-2713-50	工業洗衣機	Industrial Washing Machine	110
177	UNI-2800-40-S	工業乾衣機	Industrial Drying Tumbler	121
178	UNI-2800-40-E	工業乾衣機	Industrial Drying Tumbler	121
179	NS-2800-100-E	工業乾衣機	Industrial Drying Tumbler	121
180	NS-2800-100-G	工業乾衣機	Industrial Drying Tumbler	121
181	NS-2800-100-O	工業乾衣機	Industrial Drying Tumbler	121
182	NS-2800-100-S	工業乾衣機	Industrial Drying Tumbler	121
183	NS-2800-200-G	工業乾衣機	Industrial Drying Tumbler	121
184	NS-2800-200-O	工業乾衣機	Industrial Drying Tumbler	121
185	NS-2800-200-S	工業乾衣機	Industrial Drying Tumbler	121
186	NS-2800-300-G	工業乾衣機	Industrial Drying Tumbler	121
187	NS-2800-300-O	工業乾衣機	Industrial Drying Tumbler	121
188	NS-2800-300-S	工業乾衣機	Industrial Drying Tumbler	121
189	NS-2800-50-E	工業乾衣機	Industrial Drying Tumbler	121
190	NS-2800-50-S	工業乾衣機	Industrial Drying Tumbler	121

# 索引 Index

序號	產品編號	中文精簡說明	英文精簡說明	頁數
191	NS-2800-70-E	工業乾衣機	Industrial Drying Tumbler	121
192	NS-2800-70-S	工業乾衣機	Industrial Drying Tumbler	121
193	NS-2801-3-S	節能乾衣機	Energy Saving Drying Tumbler	116
194	NS-2801A-4-S	節能乾衣機	Energy Saving Drying Tumbler	117
195	NS-2801B-4-S	節能乾衣機	Energy Saving Drying Tumbler	117
196	NS-2805-3-G	工業乾衣機	Industrial Drying Tumbler	118
197	NS-2805-3-O	工業乾衣機	Industrial Drying Tumbler	118
198	NS-2805-3-S	工業乾衣機	Industrial Drying Tumbler	118
199	NS-2805-5.5-G	工業乾衣機	Industrial Drying Tumbler	118
200	NS-2805-5.5-O	工業乾衣機	Industrial Drying Tumbler	118
201	NS-2805-5.5-S	工業乾衣機	Industrial Drying Tumbler	118
202	NS-2806A-4-G	工業乾衣機	Industrial Drying Tumbler	119
203	NS-2806A-4-O	工業乾衣機	Industrial Drying Tumbler	119
204	NS-2806A-4-S	工業乾衣機	Industrial Drying Tumbler	119
205	NS-2806B-4-G	工業乾衣機	Industrial Drying Tumbler	119
206	NS-2806B-4-O	工業乾衣機	Industrial Drying Tumbler	119
207	NS-2806B-4-S	工業乾衣機	Industrial Drying Tumbler	119
208	NS-2810	熱風乾布樣板機	Hot Air Fabric Sample Drying Machine	122
209	NS-2810-1	熱風乾布樣板機	Hot Air Fabric Sample Drying Machine	122
210	NS-3110	剪線頭機	Thread Trimming Machine	071
211	NS-3301A	清除衣物污垢台	Cleaning Table	067
212	NS-3302A	清除衣物污垢台	Cleaning Table	067
213	NS-3400-10	真空抽濕泵連氣水分離罐	Vacuum Pump With Air Container	160
214	NS-3400-15	真空抽濕泵連氣水分離罐	Vacuum Pump With Air Container	160
215	NS-3400-20	真空抽濕泵連氣水分離罐	Vacuum Pump With Air Container	160
216	NS-3400-25	真空抽濕泵連氣水分離罐	Vacuum Pump With Air Container	160
217	NS-3400-30	真空抽濕泵連氣水分離罐	Vacuum Pump With Air Container	160
218	NS-3400-7.5	真空抽濕泵連氣水分離罐	Vacuum Pump With Air Container	160
219	NS-3401-1.5	抽風泵	Vacuum Pump	161
220	NS-3401-3	抽風泵	Vacuum Pump	161
221	NS-3401-4	抽風泵	Vacuum Pump	161
222	NS-3402-3	鼓風機	Blower	161
223	NS-3403-3	3匹真空泵連水箱	3HP Vacuum Pump With Tank	161
224	NS-3403-5	5匹真空泵連水箱	5HP Vacuum Pump With Tank	161
225	NS-3500	抽濕熨台 28" x 40"	Vacuum Ironing Table 28" x 40"	064
226	NS-3500B	抽濕熨台 28" x 40"	Vacuum Ironing Table 28" x 40"	064
227	NS-3501	抽濕熨台 28" x 48"	Vacuum Ironing Table 28" x 48"	064
228	NS-3501B	抽濕熨台 28" x 48"	Vacuum Ironing Table 28" x 48"	064
229	NS-3502	抽濕熨台 32" x 48"	Vacuum Ironing Table 32" x 48"	064
230	NS-3502B	抽濕熨台 32" x 48"	Vacuum Ironing Table 32" x 48"	064
231	NS-3503	抽濕熨台 32" x 54"	Vacuum Ironing Table 32" x 54"	064
232	NS-3503B	抽濕熨台 32" x 54"	Vacuum Ironing Table 32" x 54"	064
233	NS-3504	抽濕熨台 36" x 54"	Vacuum Ironing Table 36" x 54"	064
234	NS-3504B	抽濕熨台 36" x 54"	Vacuum Ironing Table 36" x 54"	064
235	NS-3505	抽濕熨台 36" x 60"	Vacuum Ironing Table 36" x 60"	064
236	NS-3505B	抽濕熨台 36" x 60"	Vacuum Ironing Table 36" x 60"	064
237	NS-3506	抽濕熨台 32" x 60"	Vacuum Ironing Table 32" x 60"	064
238	NS-3506B	抽濕熨台 32" x 60"	Vacuum Ironing Table 32" x 60"	064

序號	產品編號	中文精簡說明	英文精簡說明	頁數
239	NS-3507	抽濕熨台 36" x 48"	Vacuum Ironing Table 36" x 48"	064
240	NS-3507B	抽濕熨台 36" x 48"	Vacuum Ironing Table 36" x 48"	064
241	NS-3520	單臂抽濕熨台 28" x 40"	Vacuum Ironing Table With Single Buck 28" x 40"	065
242	NS-3521	單臂抽濕熨台 28" x 48"	Vacuum Ironing Table With Single Buck 28" x 48"	065
243	NS-3522	單臂抽濕熨台 32" x 48"	Vacuum Ironing Table With Single Buck 32" x 48"	065
244	NS-3523	單臂抽濕熨台 32" x 54"	Vacuum Ironing Table With Single Buck 32" x 54"	065
245	NS-3531	單臂女裝抽濕熨台 - 右	Vacuum Ironing Table With Single Buck-Right	066
246	NS-3532	單臂女裝抽濕熨台 - 右	Vacuum Ironing Table With Single Buck-Right	066
247	NS-3533	單臂女裝抽濕熨台 - 左	Vacuum Ironing Table With Single Buck-Left	066
248	NS-3534	單臂女裝抽濕熨台 - 左	Vacuum Ironing Table With Single Buck-Left	066
249	NS-3541	雙臂抽濕熨台 32" x 48"	Vacuum Ironing Table With Double Buck 32" x 48"	065
250	NS-3542	雙臂抽濕熨台 36" x 48"	Vacuum Ironing Table With Double Buck 36" x 48"	065
251	NS-3543	雙臂抽濕熨台 32" x 54"	Vacuum Ironing Table With Double Buck 32" x 54"	065
252	NS-3544	雙臂抽濕熨台 36" x 60"	Vacuum Ironing Table With Double Buck 36" x 60"	065
253	NS-3600B	電蒸汽熨斗(手撥式)	Electric Steam Iron(Swing Handle Type)	058
254	NS-3601	電蒸汽熨斗(微動開關式)	Electric Steam Iron(Micro Switch Type)	058
255	NS-3601A	電蒸汽熨斗(微動開關式)	Electric Steam Iron(Micro Switch Type)	058
256	NS-3602A	電蒸汽熨斗-全套(微動開關式)	Electric Steam Iron(Micro Switch Type) Complete	058
257	NS-3602B	電蒸汽熨斗(微動開關式)	Electric Steam Iron(Micro Switch Type)	059
258	NS-3604	電蒸汽熨斗(手撥式)	Electric Steam Iron(Swing Handle Type)	059
259	NS-3700	全蒸汽熨斗(手撥式)	Steam Heated Iron(Swing Handle)	059
260	NS-3701	全蒸汽熨斗(按手式)	Steam Heated Iron(Press Handle Type)	059
261	NS-3702	全蒸汽熨斗(按手式)	Steam Heated Iron(Press Handle Type)	060
262	NS-3703	全蒸汽熨斗(按手式)	Steam Heated Iron(Press Handle Type)	060
263	NS-3704	全蒸汽熨斗(手撥式)	Steam Heated Iron(Swing Handle)	060
264	NS-3706	全蒸汽熨斗(手撥式)	Steam Heated Iron(Swing Handle)	060
265	NS-3800A	吊水門	Bottle Iron	060
266	NS-5502	前筒折熨機	Front Placket Folding Machine	046
267	NS-5503	側袖折熨機	Sleeve Placket Folding And Ironing Machine	044
268	NS-5504	真空折熨機	Vacuum Folding And Ironing Machine	045
269	NS-5600-450	粘合機(自動平衡系統)	Fusing Machine(Automatic Balancing System)	023
270	NS-5601	褲頭粘合機	Waistband Fusing Machine	087
271	NS-5610-600	粘合機	Fusing Machine	024
272	NS-5610-900	粘合機	Fusing Machine	024
273	NS-5620	油壓平面式粘合機	Hydraulic Plane Fusing Machine	027
274	NS-5630-700	油壓平面式粘合機	Hydraulic Plane Fusing Machine	025
275	NS-5650	耳仔鑷熨機	Belt Rotary Pressing Machine	087
276	NS-6001-1	襯衫前幅鈕子收料架	Shirt Front Button Stacker	052
277	NS-6002-1	襯衫前幅鈕筒切模器連收料架	Shirt Front Button Placket Interlining Cutting Device with Stacker	053
278	NS-6006	氣動裁片夾	Pneumatic Material Clip Stand	056
279	NS-6007	吹氣系統	Air Jet Device	057
280	NS-6008	後氣動裁片夾連檯面	Back Pneumatic Material Clip Stand With Table Top	057
281	NS-6009	左側裁片收料架	Table Left Material Stacker	054
282	NS-6012-1	小裁片收料架	Small Pieces Stacker	055
283	NS-6013	袖口/下級推放架	Cuff/Collar Band Push Clamp	055
284	NS-6014	2段針距控制器	Two Stitch Length Device	057
285	NS-6018	台前推料架	Front Push Clamp With Table	055
286	NS-6020	活動氣動裁片夾	Movable Pneumatic Material Clip Stand	056



# 索引 Index

序號	產品編號	中文精簡說明	英文精簡說明	頁數
383	NS-8623A	立體尖褶定型機	3-D Pleating Machine	104
384	NS-8626	自動壓熨機	Automatic Pressing Machine	105
385	NS-8630	多層手擦架	Multi-BuckHand Brushing Stand	103
386	NS-8632	牛仔褲推壓壓皺機	Jeans Scrunch Machine	104
387	NS-8634	臥式褲像架	Horizontal Trousers Frame	102
388	NS-8812A-25	水濺式雙頭人像噴藥機	Water Curtain Chemical Spray Cabinet With Two T-Shirt Dummy	100
389	NS-8812A-50	水濺式四頭人像噴藥機	Water Curtain Chemical Spray Cabinet With Four T-Shirt Dummy	100
390	NS-8813A-25	水濺式雙頭褲像噴藥機	Water Curtain Chemical Spray Cabinet With Two Pants Dummy	098
391	NS-8813A-50	水濺式五頭褲像噴藥機	Water Curtain Chemical Spray Cabinet With Five Pants Dummies	099
392	NS-8906	自動轉頭女裝襯衫後幅壓平機	Automatic Rotation Lady Shirt Back Press	153
393	NS-8933-A	自動雙頭粘合機	Automatic Double Buck Fusing Press	028
394	NS-8933-H	自動雙頭粘合機	Automatic Double Buck Fusing Press	028
395	NS-8933-L	自動雙頭粘合機	Automatic Double Buck Fusing Press	028
396	NS-8933-S	自動雙頭粘合機	Automatic Double Buck Fusing Press	028
397	NS-8933-XL	自動雙頭粘合機	Automatic Double Buck Fusing Press	028
398	NS-8934	自動三頭粘合壓平機	Automatic Triple-Buck Fusing Press	029
399	NS-8934-L	自動三頭粘合壓平機	Automatic Triple-Buck Fusing Press	029
400	NS-8955	自動轉頭雙袖壓平機	Automatic Rotation Double Sleeve Press	144
401	NS-8955F	自動轉頭女裝雙袖壓平機	Automatic Rotation Lady Blouse Double Sleeve Press	152
402	NS-8960	自動轉頭電加熱式襯衫後幅壓平機	Automatic Rotation Electric Heated Shirt Back Press	145
403	NS-8962	自動轉頭電加熱式男裝衫前幅左/右壓平機	Automatic Rotation Electric Heated Man Shirt Front L/R Press	146
404	NS-8966	自動轉頭攪杆壓平機	Automatic Rotation Yoke Press	142
405	NS-9083S-N	針織龜背貼折熨機 - 單頭	Pneumatic Steam Pocket Creasing Machine-Single Head	041
406	NS-9083S-ND	針織龜背貼折熨機 - 雙頭	Knit Back Patch Creasing Machine - Double Head	041
407	NS-9084S-L	自動風壓蒸汽折袋機 - 大碼	Knit Back Patch Creasing Machine - Single Head	040
408	NS-9084S-LD	自動風壓蒸汽折袋機 - 雙頭	Pneumatic Steam Pocket Creasing Machine-Double Head	040
409	NS-9084S-N	自動風壓蒸汽折袋機 - 單頭	Pneumatic Steam Pocket Creasing Machine-Extra Large	040
410	NS-9084S-ND	自動風壓蒸汽折袋機 - 雙頭	Pneumatic Steam Pocket Creasing Machine-Double Head	040
411	NS-9085-D-L	牛仔褲折袋機 - 加大	Jeans Pocket Creasing Machine - Large	085
412	NS-9085-D-N	牛仔褲折袋機	Jeans Pocket Creasing Machine	085
413	NS-9205	自動前筒粘合機	Automatic Placket Fusing Machine	026
414	NS-9255	自動雙袖壓平機	Automatic Double Sleeve Pressing Machine	144
415	NS-9259	男裝襯衫後幅壓平機	Man Shirt Back Press	146
416	NS-9264	男裝襯衫右前幅壓平機	Man Shirt Front Right Press	147
417	NS-9264F	女裝襯衫右前幅壓平機	Lady Shirt Front Right Press	154
418	NS-9265	男裝襯衫左前幅壓平機	Man Shirt Front Left Press	147
419	NS-9265F	女裝襯衫左前幅壓平機	Lady Shirt Front Left Press	154
420	NS-9301	自動點模機	Automatic Spot Welding Machine	022
421	NS-9401	自動雙攪杆壓平機	Automatic Double Yoke Pressing Machine	142
422	NS-9401F	自動女裝雙攪杆壓平機	Automatic Lady Blouse Double Yoke Press	151
423	NS-9501	自動轉頭袖山縫壓平機	Automatic Rotation Arm Hole Press	125
424	NS-9502	自動轉頭側縫壓平機	Automatic Rotation Side Seam Press	126
425	NS-9503	自動轉頭雙側袖筒壓平機	Automatic Rotation Sleeve Placket Press	128
426	NS-9504	自動轉頭攪杆壓平機	Automatic Rotation Yoke Press	129
427	NS-9512	自動轉頭公主褶壓平機	Automatic Rotation Princess Seam Press	127
428	NS-9660	自動襯衫後幅壓平機	Automatic Shirt Back Press	146
429	NS-9664	自動襯衫右前幅壓平機	Automatic Shirt Front Right Press	147
430	NS-9665	自動襯衫左前幅壓平機	Automatic Shirt Front Left Press	147
431	NS-9666	自動襯衫攪杆壓平機	Automatic Shirt Yoke Press	143

版權所有，本書任何部分之文字及圖片，  
如未獲版權持有人許可，不得以任何方式抄襲或翻印。

All rights reserved. No part of this publication may be reproduced,  
stored in a retrieval system, or transmitted, in any form or by any means,  
electronic, mechanical, photocopying, recording or otherwise,  
without the prior permission of the copyright holder.

# Ngai Shing Development Limited 藝誠(余氏)發展有限公司

香港九龍長沙灣永康街五十二號地下

G/F., 52 Wing Hong Street, Cheung Sha Wan, Kowloon, Hong Kong

Tel : (852) 2742 0078, 2741 9981

Fax : (852) 2785 3149

Website : <http://www.ngaishing.com>

Email: [info@ngaishing.com](mailto:info@ngaishing.com)